

# KAWAI

## CN27 Owner's Manual

---

Preparation Before Use

---

Playing the Piano

---

Internal Songs

---

Recorder

---

Settings

---

Appendix

EN



**Thank you for purchasing this Kawai CN27 digital piano.**

This owner's manual contains important information regarding the instrument's usage and operation.

Please read all sections carefully, keeping this manual handy for future reference.

# Important Safety Instructions

## SAVE THESE INSTRUCTIONS

INSTRUCTIONS PERTAINING TO A RISK OF FIRE, ELECTRIC SHOCK, OR INJURY TO PERSONS



### WARNING

TO REDUCE THE RISK OF FIRE OR ELECTRIC SHOCK, DO NOT EXPOSE THIS PRODUCT TO RAIN OR MOISTURE.

**AVIS : RISQUE DE CHOC ELECTRIQUE - NE PAS OUVRIR.**

TO REDUCE THE RISK OF ELECTRIC SHOCK, DO NOT OPEN THE AC ADAPTOR.  
NO USER-SERVICEABLE PARTS INSIDE. REFER SERVICING TO QUALIFIED SERVICE PERSONNEL.



The lightning flash with arrowhead symbol, within an equilateral triangle, is intended to alert the user to the presence of uninsulated "dangerous voltage" within the product's enclosure that may be of sufficient magnitude to constitute a risk of electric shock to persons.



The exclamation point within an equilateral triangle is intended to alert the user to the presence of important operating and maintenance (servicing) instructions in the literature accompanying the product.

### Examples of Picture Symbols



denotes that care should be taken.  
The example instructs the user to take care not to allow fingers to be trapped.



denotes a prohibited operation.  
The example instructs that disassembly of the product is prohibited.



denotes an operation that should be carried out.  
The example instructs the user to remove the power cord plug from the AC outlet.

### Read all the instructions before using the product.

- 1) Read these instructions.
- 2) Keep these instructions.
- 3) Heed all warnings.
- 4) Follow all instructions.
- 5) Do not use this apparatus near water.
- 6) Clean only with dry cloth.
- 7) Do not block any ventilation openings. Install in accordance with the manufacturer's instructions.
- 8) Do not install near any heat sources such as radiators, heat registers, stoves, or other apparatus (including amplifiers) that produce heat.
- 9) Do not defeat the safety purpose of the polarized or grounding-type plug. A polarized plug has two blades with one wider than the other. A grounding type plug has two blades and a third grounding prong. The wide blade or the third prongs are provided for your safety. If the provided plug does not fit into your outlet, consult an electrician for replacement of the obsolete outlet.
- 10) Protect the power cord from being walked on or pinched particularly at plugs, convenience receptacles, and the point where they exit from the apparatus.
- 11) Only use attachments/accessories specified by the manufacturer.
- 12) Use only with the cart, stand, tripod, bracket, or table specified by the manufacturer, or sold with the apparatus. When a cart is used, use caution when moving the cart/apparatus combination to avoid injury from tip-over. 
- 13) Unplug this apparatus during lightning storms or when unused for long periods of time.
- 14) Refer all servicing to qualified service personnel. Servicing is required when the apparatus has been damaged in any way, such as power-supply cord or plug is damaged, liquid has been spilled or object have fallen into the apparatus, the apparatus has been exposed to rain or moisture, does not operate normally, or has been dropped.

**WARNING - When using electric products, basic precautions should always be followed, including the following.**



## WARNING

Indicates a potential hazard that could result in death or serious injury if the product is handled incorrectly.

**The product should be connected to an AC outlet of the specified voltage.**



- If you are going to use an AC power cord, make sure that its has the correct plug shape and conforms to the specified power voltage.
- Failure to do so may result in fire.

**Do not insert or disconnect the power cord plug with wet hands.**



Doing so may cause electric shock.

**Take care not to allow any foreign matter to enter the product.**

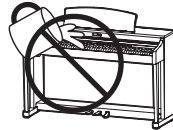

Entry of water, needles or hair pins may result in breakdown or short-circuit. The product shall not be exposed to dripping or splashing. No objects filled with liquids, such as vases, shall be placed on the product.

**The chair must be used properly (it must be used only when playing the product).**

- Do not play with it or stand on it.
- Only one person is allowed to sit on it.
- Do not sit on it when opening the lid.
- Re-tighten the bolts occasionally.

Doing so may cause the chair to fall over or your fingers to be trapped, resulting in injury.

**When using the headphones, do not listen for long periods of time at high volume levels.**



Doing so may result in hearing problems.

**Do not lean against the keyboard.**

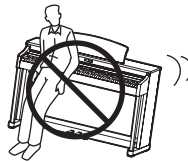

Doing so may cause the product to fall over, resulting in injury.

**Do not disassemble, repair or modify the product.**

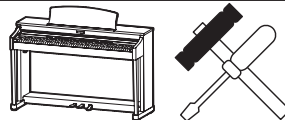

Doing so may result in product breakdown, electric shock or short-circuit.

**When disconnecting the AC power cord's plug, always hold the plug and pull it to remove it.**



- Pulling the AC power cord itself may damage the cord, causing a fire, electric shock or short-circuit.

**The product is not completely disconnected from the power supply even when the power switch is turned off. If the product will not be used for a long time, unplug the AC power cord from the AC outlet.**



- Failure to do so may cause fire in case of lightning.
- Failure to do so may over-heat the product, resulting in fire.

**This product may be equipped with a polarized line plug (one blade wider than the other). This is a safety feature. If you are unable to insert the plug into the outlet, contact an electrician to replace your obsolete outlet. Do not defeat the safety purpose of the plug.**

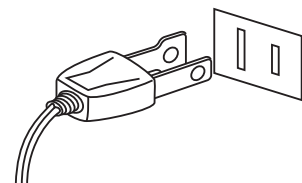

**It is a good practice to have the instrument near the AC outlet and the power cord plug in a position so that it can readily be disconnected in an emergency because electricity is always charging while the plug is in the AC outlet even in a power switch off condition.**



## CAUTION

Indicates a potential hazard that could result in injury or damage to the product or other property if the product is handled incorrectly.

**Do not use the product in the following areas.**

- Areas, such as those near windows, where the product is exposed to direct sunlight
- Extremely hot areas, such as near a heater
- Extremely cold areas, such as outside
- Extremely humid areas
- Areas where a large amount of sand or dust is present
- Areas where the product is exposed to excessive vibrations

Using the product in such areas may result in product breakdown. Use the product only in moderate climates (not in tropical climates).

**Use only the AC adaptor included with this instrument to power the instrument.**

- Do not use other AC adaptors to power this instrument.
- Do not use the included AC adaptor or AC power cord to power other equipment.

**When you close the keyboard cover, close it gently.**



Closing it roughly may trap your fingers, resulting in injury.

**Before connecting cords, make sure that the power to this product and other devices is turned OFF.**

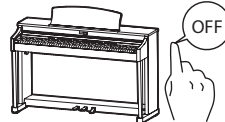

Failure to do so may cause breakdown of this product and other devices.

**Do not drag the product on the floor. Take care not to drop the product.**

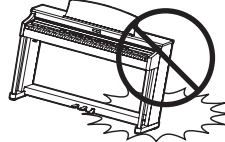

Please lift up the product when moving it. Please note that the product is heavy and must be carried by more than two persons. Dropping the product may result in breakdown.

**Do not place the product near electrical appliances such as TVs and radios.**

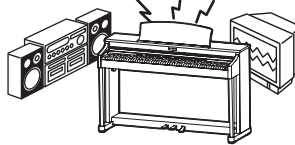

- Doing so may cause the product to generate noise.
- If the product generates noise, move the product sufficiently away from the electrical appliance or connect it to another AC outlet.

**When connecting the AC power cord and other cords, take care not to get them tangled.**



Failure to do so may damage them, resulting in fire, electric shock or short-circuit.

**Do not wipe the product with benzene or thinner.**



- Doing so may result in discoloration or deformation of the product.
- When cleaning the product, put a soft cloth in lukewarm water, squeeze it well, then wipe the product.

**Do not stand on the product or exert excessive force.**



- Doing so may cause the product to become deformed or fall over, resulting in breakdown or injury.

**Do not place naked flame, such as lighted candles on the product.**

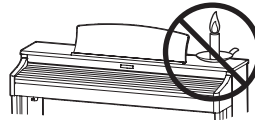

Doing so may cause the illumination to fall over, resulting in fire.

**Ensure that the ventilation is not impeded by covering the ventilation openings with items, such as newspaper, table-cloths, curtains, etc.**

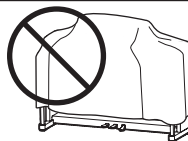

Failure to do so may over-heat the product, resulting in fire.

**The product should be located so that its location or position does not interfere with its proper ventilation. Ensure a minimum distance of 5cm around the product for sufficient ventilation.**

### The product should be serviced by qualified service personnel when:

- The power supply cord or the plug has been damaged.
- Objects have fallen, or liquid has been spilled into the product.
- The product has been exposed to rain.
- The product does not appear to operate normally or exhibits a marked change in performance.
- The product has been dropped, or the enclosure damaged.

#### Notes on Repair

Should an abnormality occur in the product, immediately turn the power OFF, disconnect the power cord plug, and then contact the shop from which the product was purchased.

#### CAUTION:

To prevent electric shock, match wide blade of plug to wide slot, fully insert.

#### ATTENTION:

Pour éviter les chocs électriques, introduire la lame la plus large de la fiche dans la borne correspondante de la prise et pousser jusqu'au fond.



#### An information on Disposal for users

If your product is marked with this recycling symbol it means that, at the end of its life, you must dispose of it separately by taking it to an appropriate collection point.

You should not mix it with general household waste. Disposing of this product correctly will prevent potential negative effects on the environment and human health which could otherwise arise due to inappropriate waste handling.

For further details, please contact your local authority.  
(European Union only)

### Instruction for AC power cord (U.K.)

#### IMPORTANT

THE WIRES IN THIS MAINS LEAD ARE COLOURED IN ACCORDANCE WITH THE FOLLOWING CODE.

BLUE : NEUTRAL  
BROWN : LIVE

As the colours of the wires in the mains lead of this apparatus may not correspond with the coloured markings identifying the terminals in your plug, proceed as follows:

The wire which is coloured BLUE must be connected to the terminal which is marked with the letter N or coloured BLACK.

The wire which is coloured BROWN must be connected to the terminal which is marked with the letter L or coloured RED.

Do not plug either terminal of the power cord to the the ground od AC outlet on the wall.

### FCC Information (U.S.A)

**CAUTION:** Changes or modifications not expressly approved by the party responsible for compliance could void the user's authority to operate the equipment.

**NOTE:** This equipment has been tested and found to comply with the limits for a Class B digital device, pursuant to Part 15 of the FCC Rules. These limits are designed to provide reasonable protection against harmful interference in a residential installation. This equipment generates, uses and can radiate radio frequency energy and, if not installed and used in accordance with the instructions, may cause harmful interference to radio communications. However, there is no guarantee that interference will not occur in a particular installation. If this equipment does cause harmful interference to radio or television reception, which can be determined by turning the equipment off and on, the user is encouraged to try to correct the interference by one or more of the following measures:

- Reorient or relocate the receiving antenna.
- Increase the separation between the equipment and receiver.
- Connect the equipment into an outlet on a circuit different from that to which the receiver is connected.
- Consult the dealer or an experienced radio/TV technician for help.

## Declaration of Conformity

Products :	Electronic Piano
Model Number :	CN27
Responsible Party Name :	Kawai America Corporation
Address :	2055 East University Drive Rancho Dominguez, CA 90220
Telephone	310-631-1771

This device complies with Part 15 of the FCC Rules.

Operation is subject to the following two conditions:

- (1) this device may not cause harmful interference, and
- (2) this device must accept any interference received, including interference that may cause undesired operation.

This applies only to products distributed by Kawai America Corporation.

The nameplate label is located on the underside of the instrument, as indicated below.

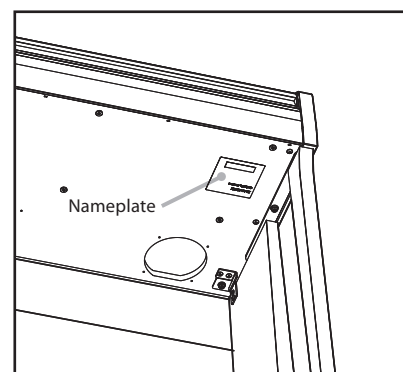

#### About Bluetooth

- The Bluetooth® word mark and logos are registered trademarks owned by the Bluetooth SIG, Inc. and any use of such marks by Kawai Musical Instruments Mfg. Co., Ltd. is under license. Other trademarks and trade names are those of their respective owners.
- Frequency Band of Radio: 2400~2483.5 MHz Maximum Transmit Power: 2.5 mW
- Availability of Bluetooth function dependent on market location.



# Table of Contents

Important Safety Instructions .....	4
Table of Contents .....	8
Preface .....	9

## Preparation Before Use

Part Names and Functions .....	10
Setting Up the Piano .....	11

## Playing the Piano

Operation Guide .....	12
1. Sound Preview .....	12
2. Vocal Assist .....	13
Selecting Sounds .....	17
Using the Pedals .....	18
Dual Mode .....	19
Four Hands Mode .....	20
Metronome .....	21

## Internal Songs

Demo Songs .....	22
Concert Magic .....	23
Concert Magic demo modes .....	24
Concert Magic Mode .....	25
Concert Magic song arrangement types .....	26
Concert Magic song list .....	27
Lesson Function .....	28
1. Selecting a lesson book/song .....	28
2. Listening to the selected lesson song .....	29
3. Practicing left and right-hand parts separately .....	30

## Recorder

Recorder .....	32
1. Recording a song .....	32
2. Playing back a song .....	33
3. Erasing recorded songs .....	33

## Settings

Keyboard and Sound Settings .....	34
1. Reverb .....	34
2. Brilliance .....	35
3. Tuning .....	35
4. Transpose .....	35
5. Touch .....	36
6. Virtual Technician (Smart Mode) .....	37
7. Spatial Headphone Sound .....	38
8. Phones Type .....	38
Startup Settings .....	39
Auto Power Off .....	39
Bluetooth® MIDI .....	40
Sound Preview/Vocal Assist Volume .....	40
Vocal Assist On/Off .....	41
Factory Reset .....	41

## Appendix

Connecting to Other Devices .....	42
USB MIDI (USB to Host connector) .....	43
Troubleshooting .....	44
User Key Volume .....	45
Assembly Instructions .....	47
Demo Song List .....	51
Concert Magic Song List .....	51
Lesson Function Song Lists .....	52
Specifications .....	54

\* For information regarding MIDI functions and settings, please download the supplementary PDF manual from the Kawai Japan website:  
<http://www.kawai-global.com>



# Preface

## ■ About this Owner's Manual

Before attempting to play this instrument, please read the **Preparation Before Use** section from page 10 of this owner's manual. This section explains the name and function of each part, how to connect the power cable, and how to turn on the power.

The **Playing the Piano** section (page 12) provides an overview of the instrument's most commonly used functions, allowing the CN27 digital piano to be enjoyed almost immediately after being connected, while the **Internal Songs** section (page 22) includes information regarding the built-in demonstration songs, Concert Magic songs, and Lesson function.

The **Recorder** section (page 32) provides instructions on how to record and play back pieces stored in the instrument's internal memory, and the **Settings** section (page 34) details the settings that can be used to adjust a number of sound and keyboard characteristics, as well as system settings.

Finally, the **Appendix** section (page 42) includes listings for all demo, Concert Magic, and Lesson function songs, a troubleshooting guide, assembly instructions, and full specification details.

## ■ CN27 Feature Highlights

### 'Responsive Hammer III' weighted-key action, with Ivory Touch key surfaces and Let-off simulation

The CN27 digital piano's *Responsive Hammer III* (RHIII) action recreates the distinctive touch of an acoustic grand piano, with its realistic movement and accurate 3-sensor technology providing a smooth, natural, and highly responsive piano playing experience. The weight of the keyboard is appropriately graded to mirror the heavier bass hammers and lighter treble hammers of an acoustic piano, while structural reinforcements within the action assembly ensure greater stability during fortissimo and staccato passages.

The CN27 digital piano also features Kawai's *Ivory Touch* key surfaces that gently absorb finger moisture to assist the player's performance, while, *let-off* simulation recreates the subtle 'notch' sensation felt when softly playing the keys of a grand piano, satisfying the expectations of the most discerning pianists.

### Shigeru Kawai SK-EX and Kawai EX instruments reproduced with Harmonic Imaging sound technology

The CN27 digital piano captures the magnificent tone of Kawai's flagship Shigeru Kawai *SK-EX* full concert grand piano. Widely regarded as the 'premier pianos of Japan', Shigeru Kawai instruments grace the stages of concert halls and musical institutions throughout the world, and are prized for their exceptional tonal clarity. In addition, the CN27 also features the distinctive sound of Kawai's highly acclaimed *EX* concert grand piano, which has frequently been selected by professional pianists in such prestigious events as the Chopin, Tchaikovsky, and Rubinstein international piano competitions, among others.

Both instruments have been carefully recorded, meticulously analysed, and faithfully reproduced with full 88-key sampling using Harmonic Imaging™ sound technology. This unique process accurately recreates the broad dynamic range of the original grand pianos, affording pianists an extraordinary level of expressiveness ranging from the softest pianissimo to the strongest, boldest fortissimo.

### Integrated Bluetooth® MIDI connectivity

In addition to standard MIDI jacks for connecting to other instruments, the CN27 digital piano also boasts integrated *Bluetooth MIDI* technology that allows the instrument to communicate with supported smart devices wirelessly. Once connected to a phone, tablet, or laptop, CN27 digital piano owners can enjoy a wide variety of exciting music-related apps that enhance their learning and playing experience without additional cables.

\* Availability of Bluetooth function dependent on market location.

### Internal Song recorder, Built-in Lesson Function

The CN27 digital piano features a three song recorder, allowing performances to be recorded to internal memory and played back at the touch of a button.

In addition, the convenient lesson feature allows aspiring pianists to learn the piano using a built-in collection of etudes from Czerny and Burgmüller, or songs from the popular Alfred course books. The left and right hand parts for each piece can be practiced separately, while adjusting the tempo allows more difficult passages to be perfected.

# Part Names and Functions

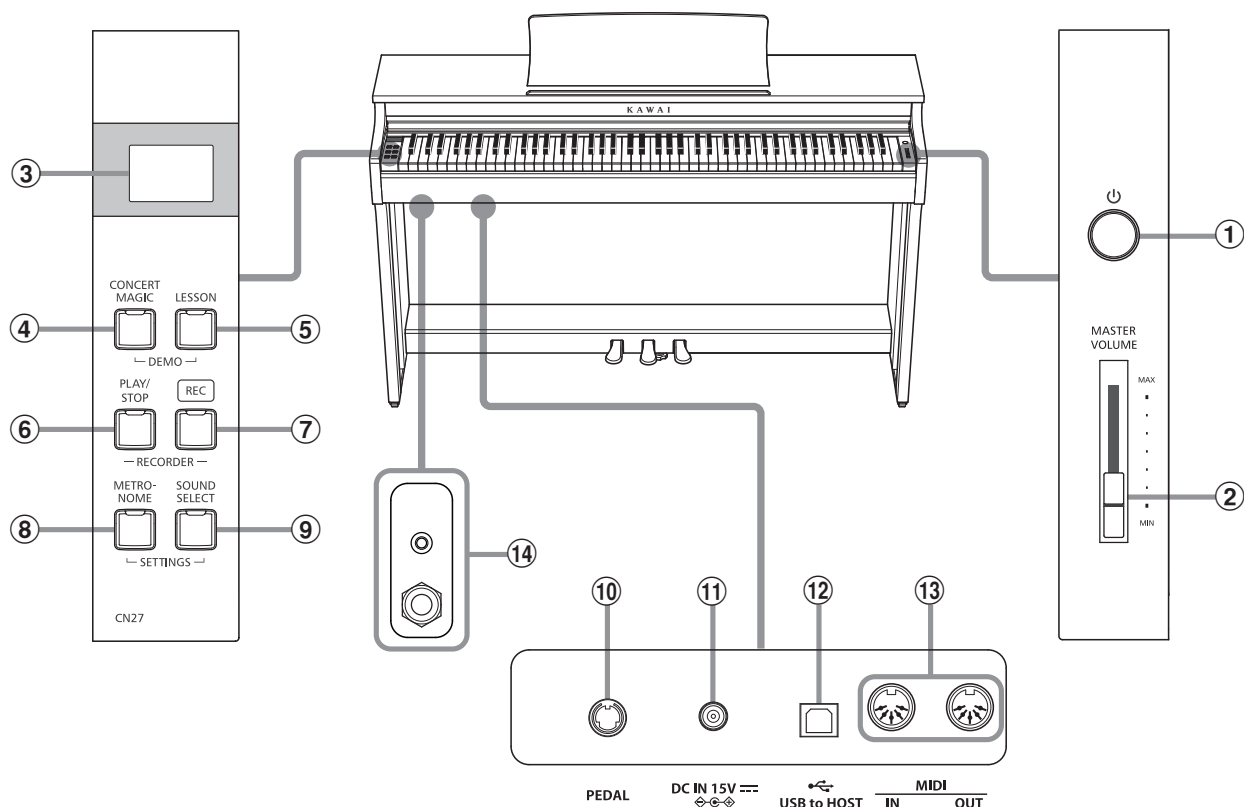

## ① POWER button

This button is used to turn the CN27 digital piano on/off. Be sure to turn off the instrument after playing.

To prevent data loss when turning off the instrument, do not disconnect the power cable until **bye** is shown in the LCD display.

## ② MASTER VOLUME slider

This slider controls the master volume level of the CN27 digital piano's built-in speakers or headphones, if connected.

## ③ LED Display

The LED display provides important information relating to the currently selected function and various other values.

\* A protective plastic film is attached to the display during production. Please remove this film before attempting to play the instrument.

## ④ CONCERT MAGIC button

This button is used to start/stop playback of the CN27 digital piano's built-in Concert Magic songs.

## ⑤ LESSON button

This button is used to select the CN27 digital piano's built-in Lesson songs.

## ⑥ PLAY / STOP button

This button is used to start/stop the playback of Recorder songs stored in memory and CN27 digital piano's built-in Lessons songs.

## ⑦ REC button

This button is used to record performances to the CN27 digital piano's internal memory.

## ⑧ METRONOME button

This button is used to turn the metronome function on/off, and also to adjust its tempo, time signature, and volume settings.

## ⑨ SOUND SELECT button

This button is used to select the sound(s) that will be heard when the keys are pressed.

## ⑩ PEDAL connector

This connector is used to connect the CN27 digital piano's pedal board to the instrument.

## ⑪ DC IN jack

This jack is used to connect the AC adaptor.

## ⑫ USB to Host port

This port is used to connect the instrument to a computer using a USB 'B to A' type cable in order to send and receive MIDI data.

## ⑬ MIDI IN / OUT jacks

These jacks are used to connect the CN27 digital piano to external MIDI devices, such as other musical instruments or a computer, in order to send and receive MIDI data.

## ⑭ PHONES jacks

These jacks are used to connect stereo headphones to the CN27 digital piano. 1/4" and 1/8" connectors are provided for convenience, and both can be used simultaneously, allowing two pairs of headphones to be connected at the same time.

## ■ Operation Guide

The separate Operation Guide provides a convenient overview of the CN27 digital piano's various button and keyboard controls.

# Setting Up the Piano

## 1. Connecting the power adaptor

Connect the AC power adaptor to the DC IN terminal located on the underside of the instrument, as indicated below.

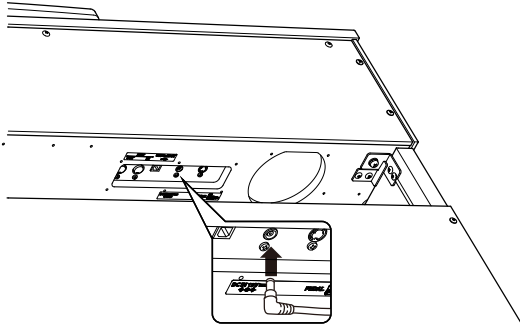

## 2. Connecting the power adaptor to an outlet

Connect the AC power adaptor to an AC outlet.

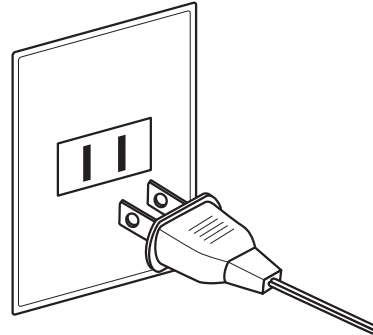

## 3. Turning on the power

Press the POWER switch, located on the right hand side of the instrument's front panel.

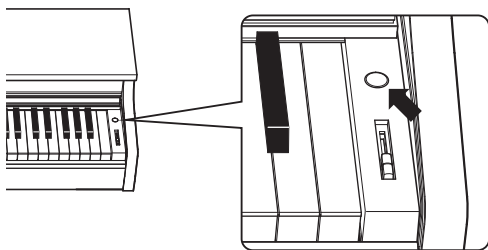

The LED indicator for the SOUND SELECT button will turn on and the SK Concert Grand sound will be selected automatically.

To prevent data loss when turning off the instrument, do not disconnect the power cable until **bye** is shown in the LCD display.

## ■ Using headphones

Use the jacks located beneath the keyboard on the left hand side, to connect stereo headphones to the CN27 digital piano.

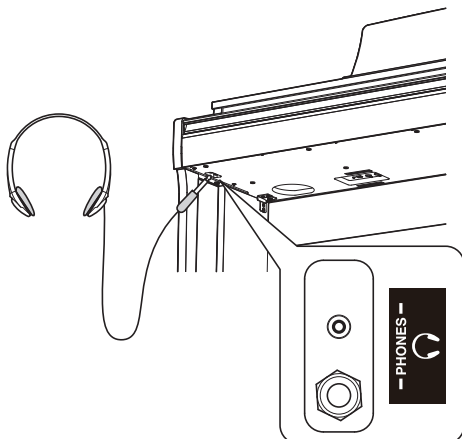

Up to two pairs of headphones can be connected and used simultaneously. When a pair of headphones is connected, sound will not be produced by the speakers.

## 4. Adjusting the volume

Move the MASTER VOLUME slider up and down to increase and decrease the volume level of the instrument's speakers, or headphones if connected.

Adjust the volume to a comfortable listening level – the middle is often a good starting point.

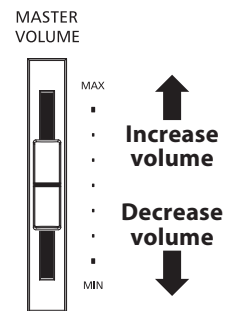

## ■ Adjusting the pedal support bolt

A pedal support bolt is attached at the base of the pedal board to aid stability when the pedals are pushed. Turn the bolt anti-clockwise until it makes contact with the floor and supports the pedals firmly.

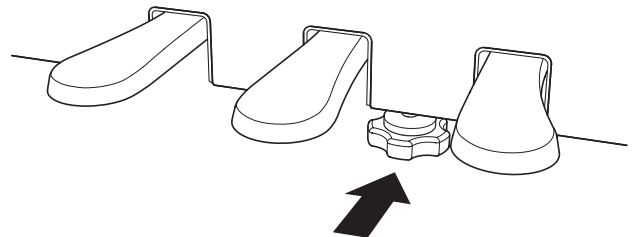

**When moving the instrument, always adjust or remove the pedal support bolt, then readjust when the instrument is in its new position.**

# Operation Guide

In addition to the side panel buttons, the CN27 can also be controlled by pressing and holding a button, then pressing a key on the keyboard. This section explains the various functions for each button, in addition to the instrument's Sound Preview and Vocal Assist features that may be useful when changing sounds or settings.

**SOUND**

**SOUND SELECT**

Sound Select																		
Classic E.Piano	Modern E.Piano	Jazz Organ	Church Organ	Harpsichord	Vibraphone	String Ensemble	Slow Strings	Choir	New Age Pad	Atmosphere								
A*0	C*1	D*1	F*1	G*1	A*1	C*2	D*2	F*2	G*2	A*2	C*3	D*3	F*3	G*3	A*3			
A0	B0	C1	D1	E1	F1	G1	A1	B1	C2	D2	E2	F2	G2	A2	B2			
SK Concert Grand	EX Concert Grand	Upright Piano	Studio Grand	Studio Grand 2	Mellow Grand	Mellow Grand 2	Modern Piano	Dual Mode On	Dual Balance Reset	Dual Balance 1	Dual Balance +	Off	Room	Lounge	Small Hall	Concert Hall	Live Hall	Cathedral
Sound Select								Dual				Reverb						
1 ~ 19								b c ⇌ S S				r E U ⇌ r o n						
* Refer to page 17.								* Refer to page 19.				* Refer to page 34.						

## 1 Sound Preview

The CN27 digital piano's Sound Preview feature plays a short musical passage to demonstrate the selected sound or sound setting when pressing.

- \* Sound Preview is only available for certain operations using the SOUND SELECT button.
- \* The volume of the Sound Preview can be adjusted (and silenced, if desired). Please refer to page 40 for more information.

### Example: Comparing two piano sounds

Press and hold the SOUND SELECT button, then press the A0 key.

A short passage performed using the SK Concert Grand sound will be played.

Press and hold the SOUND SELECT button, then press the A1 key.

A short passage performed using the Modern Piano sound will be played.

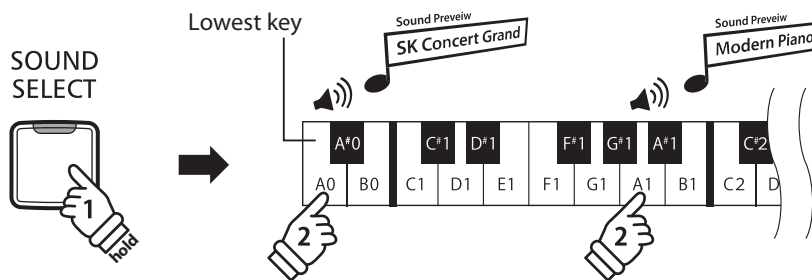

\* Refer to page 37.

**Virtual Technician**

Clean Strong Dark Rich Classical

\* Refer to page 35.

**Brilliance**  
(-10~+10)

Off - +

\* Refer to page 38.

**Spatial Headphone Sound**

Off Forward Normal Wide

C4 D4 E4 F4 G4 A4 B4 C5 D5 E5 F5 G5 A5 B5 C6 D6 E6 F6 G6 A6 B6 C7 D7 E7 F7 G7 A7 B7 C8

Off Noisiless Deep Resonance Light Resonance Soft Brilliant

**Virtual Technician**

SNT ⇌ CLN

\* Refer to page 37.

**Touch**

Touch\*  
\* Cycle through 4 setting types

etch ⇌ nrn

\* Refer to page 36.

**Phones Type**

Normal Open Semi Open Closed Inner-ear Canal

HPE ⇌ nrn

\* Refer to page 38.

## 2 Vocal Assist

The CN27 digital piano's Vocal Assist feature provides a vocal explanation of the currently selected sound, function, or setting.

\* Vocal Assist is only available for operations that use a combination of the instrument's panel buttons and keyboard.

\* Vocal Assist is disabled by default. Please refer to page 40 for information about enabling the Vocal Assist feature.

### ■ Entering Vocal Assist mode

Press and hold the desired button to activate Vocal Assist mode for that button.

The voice message "Vocal Assist Mode" will be heard, and the LED indicator for the pressed button will start to flash quickly.

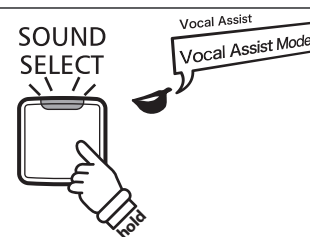

### ■ Changing settings

Release the pressed button, and press a key corresponding to the desired function/setting.

The selected function/setting name will be explained vocally.

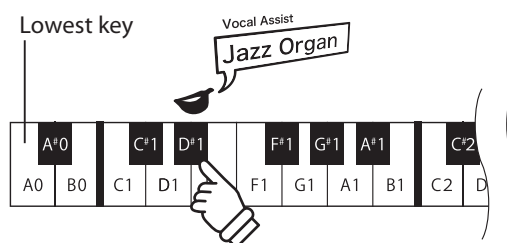

### ■ Storing or canceling a setting

Press the button with the flashing LED indicator to store the adjusted setting and deactivate the Vocal Assist mode.

Press any other button to cancel the setting and deactivate the Vocal Assist mode.

\* An example of using the Vocal Assist mode with the SOUND SELECT button is shown in the illustration.

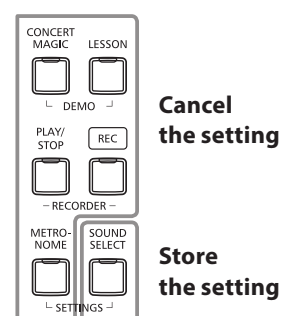

# Operation Guide

## METRONOME

\* Refer to page 21.

METRO-  
NOME



6P77 ⇌ 1-4      U01 ⇌ 005

Time Signature										Metronome Volume																													
1/4		2/4		3/4		4/4		5/4		3/8		6/8		-		+																							
A0	B0	C1	D1	E1	F1	G1	A1	B1	C2	D2	E2	F2	G2	A2	B2	C3	D3	E3	F3	G3	A3	B3	C4	D4	E4	F4	G4	A4	B4										
Tempo -		Tempo +		Tempo (-2)		Tempo (+2)		Metronome Tempo (3 digits)										Metronome Tempo (Musical Term)																					
								1		2		3		4		5		6		7		8		9		0													
								120												Grave																			
																														Largo									
																														Lento									
																														Larghetto									
																														Adagio									
																														Adagietto									
																														Andante									
																														Andantino									
																														Maestoso									
																														Moderato									
																														Allegretto									
																														Animato									
																														Allegro									
																														Vivace									

## CONCERT MAGIC

\* Refer to page 23.



\* If Vocal Assist is activated, the number of the selected song will be announced.

A0	B0	C1	D1	E1	F1	G1	A1	B1	C2	D2	E2	F2	G2	A2	B2	C3	D3	E3	F3	G3	A3	B3	C4	D4	E4	F4	G4	A4	B4
1	2	3	4	5	6	7	8	9	10	11	12	13	14	15	16	17	18	19	20	21	22	23	24	25	26	27	28	29	30
Twinkle, Twinkle, Little Star	In A Little Teapot	Mary Had A Little Lamb	London Bridge	Row, Row, Row Your Boat	Frere Jacques	Old MacDonald Had A Farm	Hark The Herald Angels Sing	Jingle Bells	Deck The Halls	O Come All Ye Faithful	Joy To The World	Silent Night	We Wish You A Merry Christmas	Battle Hymn Of The Republic	Yankee Doodle	Londonerry Air	Clementine	Auld Lang Syne	Oh Susanna	The Camptown Races	When The Saints Go Marching In	The Entertainer	William Tell Overture (Haydn)	Fur Elise	Clair De Lune	Skater's Waltz	Blue Danube Waltz	Gavotte (Gossec)	

Song Select

001 ~ 040

## SETTINGS

\* Refer to page 35.

\* Refer to page 35.

\* Refer to PDF manual.

\* Refer to PDF manual.

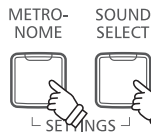

6U0N ⇌ 400      6RP ⇌ -1      PGN ⇌ 00      LCL ⇌ 00

Tuning (427 Hz~453 Hz)										Transpose (-6~+5)										Transmit MIDI Program Change										MIDI Local Control																			
440 Hz		-0.5 Hz		+0.5 Hz		Off		On		-		+		Off		On		Off		On																													
1		2		3		4		5		6		7		8		9		0		1		2		3		4		5		6		7		8		9		0		Program Number (3 digits)									
																																								P00									

\* Refer to page 35.

\* Refer to PDF manual.

C5	D5	E5	F5	G5	A5	B5	C6	D6	E6	F6	G6	A6	B6	C7	D7	E7	F7	G7	A7	B7	C8
----	----	----	----	----	----	----	----	----	----	----	----	----	----	----	----	----	----	----	----	----	----

Presto ..... 192  
 Vivacissimo ..... 184  
 Prestissimo ..... 208

C5	D5	E5	F5	G5	A5	B5	C6	D6	E6	F6	G6	A6	B6	C7	D7	E7	F7	G7	A7	B7	C8
----	----	----	----	----	----	----	----	----	----	----	----	----	----	----	----	----	----	----	----	----	----

31 Waltz Of The Flowers  
 32 Bridal Chorus  
 33 Wedding March  
 34 Pomp And Circumstance  
 35 When Irish Eyes Are Smiling  
 36 Chapipecas  
 37 Santa Lucia  
 38 Funiculi Funicula  
 39 Romance De L'amour  
 40 My Wild Irish Rose

### STARTUP SETTINGS

\* Refer to page 39.

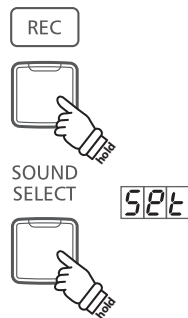

Press and hold the buttons for three seconds

### FACTORY RESET

\* Refer to page 41.

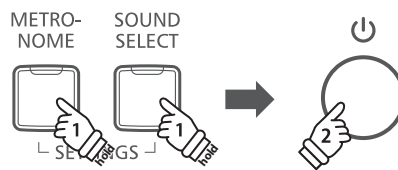

① Hold both buttons

② Turn the power on

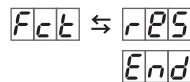

\* Refer to PDF manual.

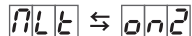

#### Multi-timbral Mode



\* Refer to page 40.

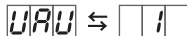

#### Sound Preview & Vocal Assist Volume

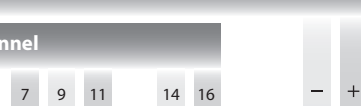

\* Refer to page 40.

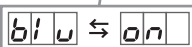

#### MIDI Channel



\* Refer to PDF manual.

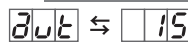

\* Refer to page 39.

# Operation Guide

## RECORDER

\* Refer to page 32.

Record song    1 ~    3

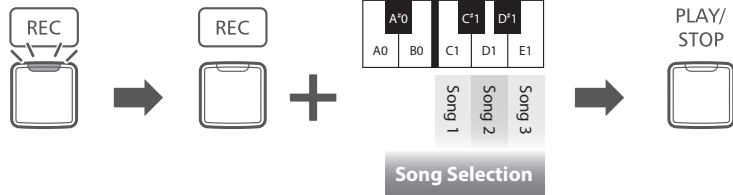

- ① Enter recording mode
- ② Select a song memory
- ③ Start recording

\* Refer to page 33.

Play song    1 ~    3

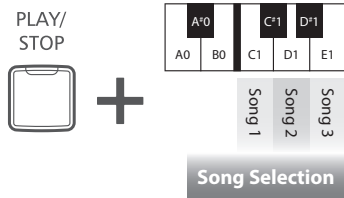

\* Refer to page 33.

Erase all songs

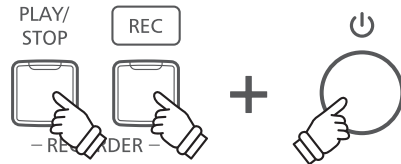

- ① Hold both buttons
- ② Turn the power on

## LESSON

\* Refer to page 28.

Selecting a Lesson book and song

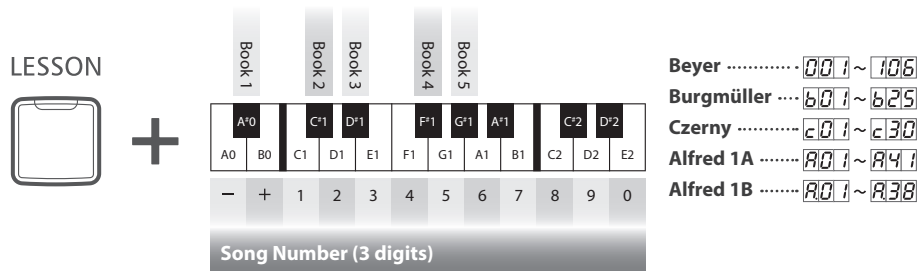

\* Refer to page 29.

Listening to the song

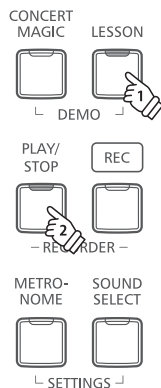

\* Refer to page 30.

Selecting the part to practice

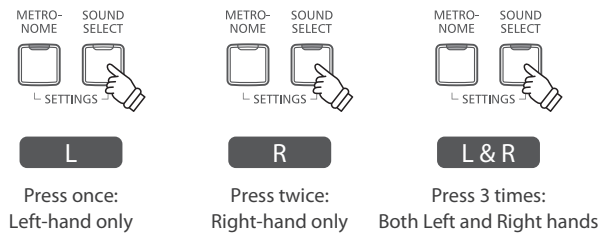



# Selecting Sounds

The CN27 digital piano features 19 different instrument sounds, which can be selected in one of two ways. By default the 'SK Concert Grand' sound will be selected automatically when the instrument is turned on.

## ■ Selecting a sound: Method 1

Operation Guide: SOUND (page 12~13)

Press and hold the SOUND SELECT button, then press one of the lowest 8 white keys or 11 black keys to selected the desired instrument sound.

	Sound name	Sound name
Selected with white keys	SK Concert Grand	Classic E.Piano
	EX Concert Grand	Modern E.Piano
	Upright Piano	Jazz Organ
	Studio Grand	Church Organ
	Studio Grand 2	Harpsichord
	Mellow Grand	Vibraphone
	Mellow Grand 2	String Ensemble
	Modern Piano	Slow Strings
Selected with black keys		Choir
		New Age Pad
		Atmosphere

## ■ Selecting a sound: Method 2

Press the SOUND SELECT button repeatedly to cycle through the 19 available instrument sounds.



\* The Sound number will be shown in the LED display.

# Using the Pedals

As with a grand piano, the CN27 digital piano features three pedals: sustain, sostenuto, and soft.

## ■ Sustain pedal (right pedal)

Depressing this pedal sustains the sound after one's hands have been lifted from the keyboard - greatly enriching the piano sound, while also assisting smooth 'legato' passages.

The sustain pedal is capable of responding to half pedaling.

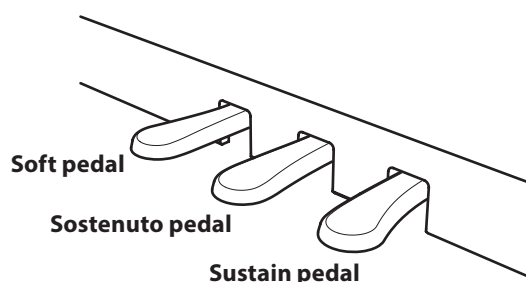

## ■ Soft pedal (left pedal)

Depressing this pedal softens the sound, reducing its volume.

When the Jazz Organ sound is selected, the soft pedal is also used to alternate the speed of the rotary speaker simulation between 'Slow' and 'Fast' effect modes.

## ■ Sostenuto pedal (centre pedal)

Depressing this pedal after playing the keyboard and before releasing the keys, sustains the sound of only those notes that have been played. Any keys that are subsequently played after the sostenuto pedal is depressed will not be sustained.

## ■ Pedal support bolt

If the pedal support bolt does not make contact with the floor, the pedal board may become damaged. Ensure that this bolt is fully extended and supports the pedals firmly.



**When moving the instrument, always adjust or remove the pedal support bolt, then readjust when the instrument is in its new position.**

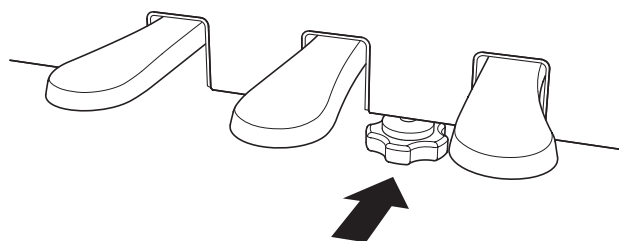

## ■ Caring for the pedals

If the surface of the pedals becomes dirty, clean the pedals using a dry dish-washing sponge. Do not attempt to clean the pedals using rust-removing solvents, abrasives or files.

## ■ Grand Feel Pedal System

The CN27 digital piano features the new Grand Feel Pedal System, which replicates the sustain, soft, and sostenuto pedal weighting of Kawai's EX Concert Grand piano.

# Dual Mode

The Dual Mode function allows two sounds to be layered together, creating a more complex sound. For example, a piano sound layered with strings, or an electric piano combined with a harpsichord etc.

## Enabling Dual Mode : Method 1

Operation Guide: SOUND (page 12~13)

Press and hold the SOUND SELECT button, then press two of the lowest 8 white keys or 11 black keys simultaneously. The sounds corresponding to the two keys will be layered together.

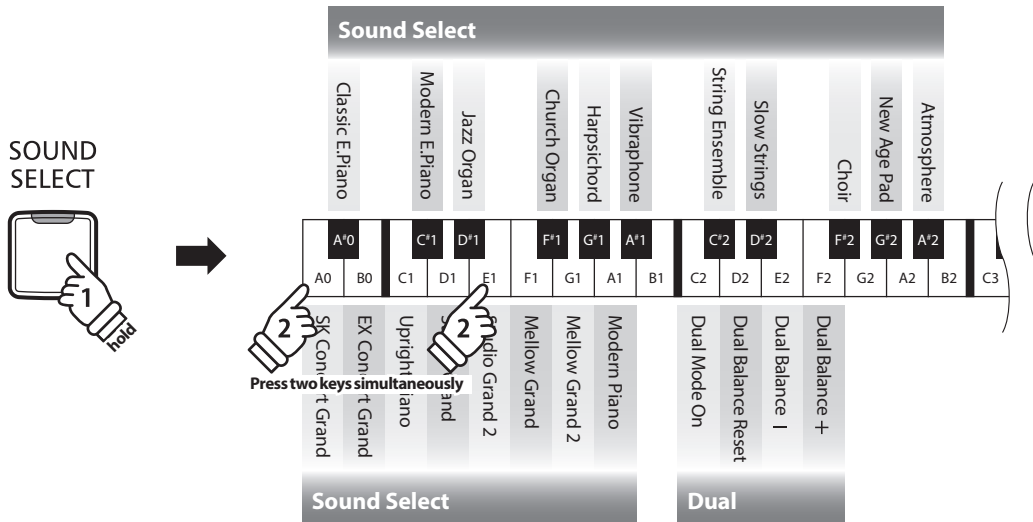

## Enabling Dual Mode : Method 2

Operation Guide: SOUND (page 12~13)

Press and hold the SOUND SELECT button, then press the C2 key. While still holding the SOUND SELECT button, press two of the lowest 8 white keys or 11 black keys in order.

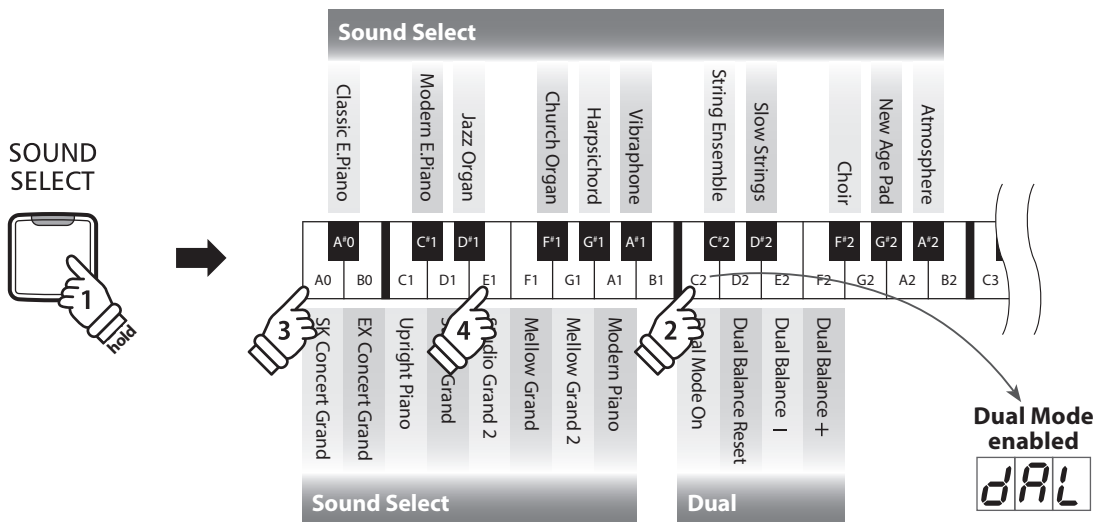

## Adjusting the volume balance

Operation Guide: SOUND (page 12~13)

Press and hold the SOUND SELECT button, then press the E2 or F2 keys repeatedly to decrease or increase the volume balance between the two sounds, or the D2 key to reset the volume balance.

\* The Dual Balance value will be shown in the LED display.

## Exiting Dual Mode

Press the SOUND SELECT button. The SK Concert Grand sound will be selected automatically and the instrument will return to normal operation.

# Four Hands Mode

The Four Hands Mode function divides the keyboard into two sections, with the sustain (right) and soft (left) pedal acting as independent sustain pedals for each section. The octave/pitch of each section is also adjusted, allowing two people to perform piano duets within the same key range using a single instrument.

## ■ Enabling Four Hands Mode

Press and hold the LESSON button, then press the D#3 key, as shown in the illustration below.

The LED indicators for the LESSON button will start to flash, indicating that Four Hands Mode is enabled.

\* The selected keyboard sound can still be changed when Four Hands Mode is enabled.

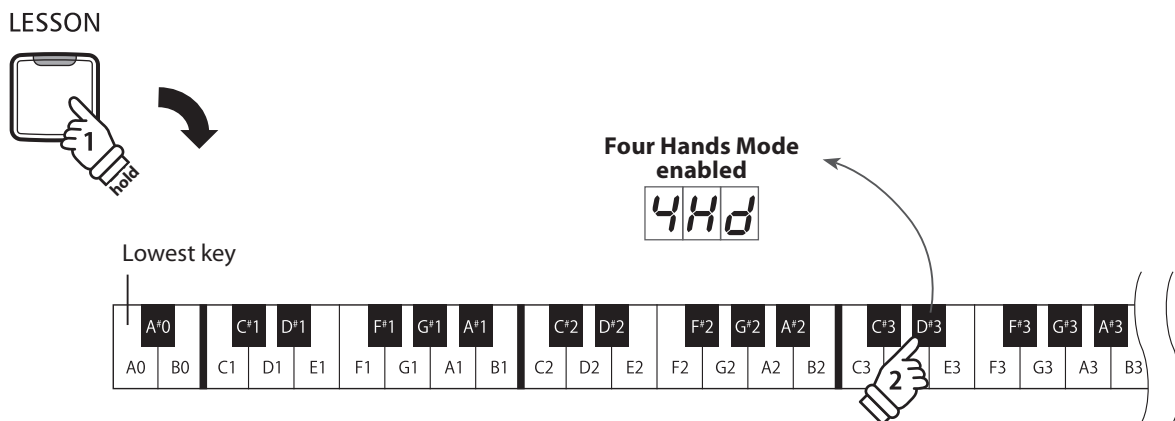

## ■ Exiting Four Hands Mode

Press the LESSON button.

The instrument will return to normal operation.

- \* With the Four Hands Mode activated, selecting a different sound will affect both the left and right sections.
- \* It is not possible to use the Recorder function with the Four Hands Mode activated.
- \* The Split Point for the Four Hands Mode is set to F4, and cannot be changed.
- \* The sostenuto pedal will affect the right section sound only.

# Metronome

The Metronome function provides a steady beat to aid practicing the piano at a consistent tempo. The time signature, volume, and tempo of the metronome can be freely adjusted.

## ■ Turning the metronome on/off

Press the METRONOME button.

The metronome will start to count and the LED indicator for the METRONOME button will turn on, indicating that the metronome is in use.

\* By default the metronome will count with a 1/4 beat at 120 bpm.

Press the METRONOME button again to stop the metronome.



## ■ Changing the metronome time signature

Operation Guide: METRONOME (page 14~15)

Press and hold the METRONOME button, then press one of the 7 lowest black assigned to the desired metronome time signature.

\* The metronome can be set to one of seven time signatures: 1/4, 2/4, 3/4, 4/4, 5/4, 3/8, and 6/8.

\* The metronome time signature will be shown in the LED display.

## ■ Adjusting the metronome volume

Operation Guide: METRONOME (page 14~15)

Press and hold the METRONOME button, then press the D#2 or F#5 keys repeatedly to decrease or increase the level of the metronome volume.

\* The metronome volume will be shown in the LED display.

## ■ Adjusting the metronome tempo

Operation Guide: METRONOME (page 14~15)

Press and hold the METRONOME button, then enter the desired tempo using the lowest 12 white keys.

\* The metronome tempo can be adjusted within the range of 10~300 bpm.

\* The metronome tempo can be entered precisely, or decreased and increased gradually.

\* The metronome tempo will be shown in the LED display.

### Method 1:

While pressing the METRONOME button, press keys 1, 5, and 0 to set the tempo to 150 bpm, or keys 0, 8 and 5 to set the tempo to 85 bpm.

### Method 2:

While pressing the METRONOME button, press the - / + keys repeatedly to gradually decrease or increase the tempo in 2 bpm increments.

It is also possible to conveniently set the metronome tempo to correspond with musical terms such as Allegro or Andante.

### Method 3:

While pressing the METRONOME button, press keys C3~E5 to select the desired tempo. The tempo value will be shown in the LED display.

# Demo Songs

The CN27 digital piano includes a selection of demonstration songs to introduce each internal sound. For a complete listing of demonstration songs, please refer to page 51 of this owner's manual.

## 1. Playing the demo songs

Press the CONCERT MAGIC and LESSON buttons simultaneously.

The LED indicators for the CONCERT MAGIC and LESSON buttons will start to flash, and the demo song for the SK Concert Grand sound will start to play.

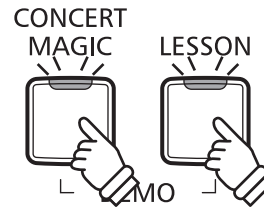

\* When the SK Concert Grand demo song has finished, another demo song will be selected at random. This process will continue until all of the demo songs have been played.

Press either the CONCERT MAGIC or LESSON buttons to stop the demo.

## 2. Selecting a demo song

Operation Guide: SOUND (page 12~13)

While the demo is playing:

To listen to the demo song for a particular sound, press and hold the SOUND SELECT button, then press one of the lowest 8 white keys or 11 black keys assigned to the desired sound.

Alternatively, press the SOUND SELECT button to skip to the next demo song.

\* The Demo song number be shown in the LED display.

Sound	Song
Classic E.Piano	Original 9
Modern E.Piano	Original 10
Jazz Organ	Original 11
Church Organ	Original 12
Harpichord	French Suite No.6 Chorale Prelude "Wachet auf, ruft uns die Stimme."
Vibraphone	Original 14
String Ensemble	Le quattro stagioni: la "Primavera"
Slow Strings	Original 16
Choir	Londonderry Air
New Age Pad	Original 18
Atmosphere	Original 19

Key	Sound	Song
A <sup>0</sup>	SK Concert Grand	1 La Campanella
B <sup>0</sup>	SK Concert Grand	2 Hungarian Rhapsodies No.6
C <sup>1</sup>	Upright Piano	3 Alpenglühchen Op.193
D <sup>1</sup>	Studio Grand	4 Original
E <sup>1</sup>	Studio Grand 2	5 Original
F <sup>1</sup>	Mellow Grand	6 Sonata No.30 Op.109
G <sup>1</sup>	Mellow Grand 2	7 La Fille aux Cheveux de lin
A <sup>1</sup>	Modern Piano	8 Original
C <sup>2</sup>	Modern Piano	9 Original
D <sup>2</sup>	Modern Piano	10 Original
F <sup>2</sup>	Modern Piano	11 Original
G <sup>2</sup>	Modern Piano	12 Original
A <sup>2</sup>	Modern Piano	13 Original
C <sup>3</sup>	Modern Piano	14 Original

# Concert Magic

The Concert Magic function allows complete beginners to enjoy playing the piano by simply selecting one of the 40 pre-programmed songs, then tapping the keyboard with a steady rhythm and tempo.

The Concert Magic songs are categorised by group and assigned to the lowest 40 white keys of the keyboard. For a complete listing of available Concert Magic songs, please refer to page 51 of this owner's manual.

## ■ Selecting a Concert Magic song

Operation Guide: Concert Magic (page 14~15)

Press and hold the CONCERT MAGIC button, then press the white key assigned to the desired Concert Magic song.

The LED indicator for the CONCERT MAGIC button will turn on, indicating that Concert Magic playing mode is in use.

\* The Concert Magic song number will be shown in the LED display.

## ■ Listening to the selected Concert Magic song

Press the PLAY/STOP button.

The LED indicator for the PLAY/STOP button will turn on and the selected Concert Magic song will start to play.

\* The selected song will play repeatedly until it is stopped.

\* To listen to a different Concert Magic song simply repeat the above step.

Press either the PLAY/STOP or CONCERT MAGIC buttons again to stop the song.

PLAY/  
STOP



## ■ Performing the selected Concert Magic song

Press keys on the keyboard.

The song will advance with every key that is pressed.

Pressing the keys gently will produce a soft sound, while pressing heavily will produce a loud sound.

Similarly, pressing the keys quickly will increase the tempo of the song, while pressing slowly will decrease the tempo.

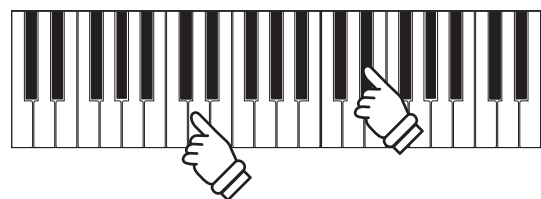

## ■ Exiting Concert Magic playing mode

Press the CONCERT MAGIC button.

The LED indicator for the CONCERT MAGIC button will turn off and the instrument will return to normal operation.

CONCERT  
MAGIC



## Concert Magic demo modes

The Concert Magic demo modes allow the Concert Magic songs to be listened to in one of three ways: All Play, Category Play, and Random Play

### ■ All Play

Press the CONCERT MAGIC button, then press the PLAY/STOP button.

The LED indicator for the PLAY/STOP button will turn on and the Concert Magic songs will start to play in numerical order.

Press either the CONCERT MAGIC or PLAY/STOP buttons again to stop song playback.

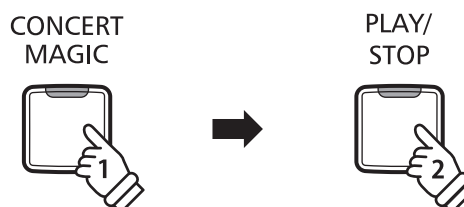

### ■ Category Play

Press and hold the CONCERT MAGIC button, then press the white key assigned to the desired Concert Magic song. While still holding the CONCERT MAGIC button, press the LESSON button.

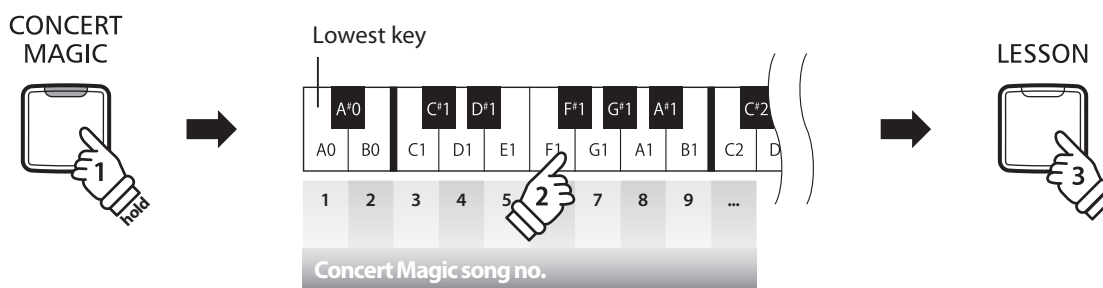

The selected Concert Magic song will start to play.

\* When the selected song finishes, the next song in the same category will start to play automatically.

### ■ Random Play

Press the CONCERT MAGIC button and then press the LESSON button.

The CN27 digital piano will play back the first Concert Magic song, followed by the remaining 39 Concert Magic songs in random order.

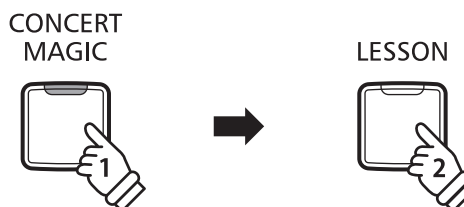



# Concert Magic Mode

The Concert Magic Mode setting changes the Concert Magic playing mode, allowing all Concert Magic songs to be played by simply tapping any key with a constant steady beat, regardless of the song arrangement type.

## ■ Concert Magic Mode

Concert Magic Mode	Description	Pedal
Normal	Concert Magic songs will be performed according to their arrangement type.	Soft
Steady Beat	All Concert Magic songs will be performed by tapping the key with a constant beat.	Sostenuto

## ■ Changing the Concert Magic Mode

Operation Guide: Concert Magic (page 14~15)

Press and hold the CONCERT MAGIC button, then press the pedal assigned to the desired Concert Magic Mode.

To select Normal mode, press and hold the CONCERT MAGIC button, then depress the Soft pedal.

To select Steady Beat mode, press and hold the CONCERT MAGIC button, then depress the Sostenuto pedal.

The selected Concert Magic Mode type will be applied immediately.

\* When the instrument is turned on, the Concert Magic Mode setting will return to the default type of 'Normal'.

## Concert Magic song arrangement types

Concert Magic songs are divided into three different arrangement types: Easy Beat (EB), Melody Play (MP), and Skillful (SK). Each arrangement type requires a different level of skill to be performed correctly.

### Easy Beat

EB

These are the easiest songs to play. To perform them, simply tap out a constant, steady beat on any key of the keyboard. For example, when playing the piece 'Für Elise', a constant, steady rhythm should be maintained throughout the song.

Key on: X

The image shows a musical score for 'Für Elise' in 3/8 time. Above the staff, a sequence of 'X' marks indicates a steady, constant rhythm. The notation includes a treble clef, a key signature of one sharp (F#), and a 3/8 time signature. The melody is written in the treble clef, and the accompaniment is in the bass clef.

### Melody Play

MP

These songs are also relatively easy to play, especially if they are familiar to the player. To perform them, tap out the rhythm of the melody on any key of the keyboard. Singing along as the rhythm is tapped can be helpful. For example, when playing the piece 'Twinkle, Twinkle, Little Star', the rhythm of the melody should be played.

\* When performing fast Concert Magic songs, it may be easier to press different keys with two alternating fingers in order to achieve greater speed.

Key on: X X X X X X X X X X X X X X X

The image shows a musical score for 'Twinkle, Twinkle, Little Star' in common time (C). Above the staff, a sequence of 'X' marks indicates the rhythm of the melody. The notation includes a treble clef, a key signature of one sharp (F#), and a common time signature. The melody is written in the treble clef, and the accompaniment is in the bass clef.

### Skillful

SK

These songs range in difficulty from moderately difficult to difficult. To perform them, tap out the rhythm of both the melody and the accompaniment notes on any key of the keyboard.

For example, when playing the piece 'Waltz of the Flowers', the rhythm of both the melody and the accompaniment should be played.

Key on: X X X X X X X X X X X X X X X

The image shows a musical score for 'Waltz of the Flowers' in 3/4 time. Above the staff, a sequence of 'X' marks indicates a complex rhythm pattern. The notation includes a treble clef, a key signature of two sharps (F# and C#), and a 3/4 time signature. The melody is written in the treble clef, and the accompaniment is in the bass clef.

## Concert Magic song list

No.	Song Name	Type
<b>Children's Songs</b>		
1	Twinkle, Twinkle, Little Star	MP
2	I'm A Little Teapot	MP
3	Mary Had A Little Lamb	MP
4	London Bridge	MP
5	Row, Row, Row Your Boat	MP
6	Frère Jacques	MP
7	Old MacDonald Had A Farm	MP

<b>Christmas Songs</b>		
8	Hark The Herald Angels Sing	MP
9	Jingle Bells	MP
10	Deck The Halls	MP
11	O Come All Ye Faithful	MP
12	Joy To The World	MP
13	Silent Night	MP
14	We Wish You A Merry Christmas	MP

<b>American Classics</b>		
15	Battle Hymn Of The Republic	MP
16	Yankee Doodle	MP
17	Londonderry Air	EB
18	Clementine	MP
19	Auld Lang Syne	MP
20	Oh Susanna	SK
21	The Camptown Races	MP
22	When The Saints Go Marching In	EB
23	The Entertainer	SK

No.	Song Name	Type
<b>Classical Selections</b>		
24	William Tell Overture	SK
25	Andante from Symphony No.94 (Haydn)	MP
26	Für Elise	EB
27	Clair De Lune	SK
28	Skater's Waltz	SK
29	Blue Danube Waltz	SK
30	Gavotte (Gossec)	SK
31	Waltz Of The Flowers	SK

<b>Special Occasions</b>		
32	Bridal Chorus	MP
33	Wedding March	SK
34	Pomp And Circumstance	SK

<b>International Songs</b>		
35	When Irish Eyes Are Smiling	EB
36	Chiapanecas	SK
37	Santa Lucia	SK
38	Funiculì Funiculà	SK
39	Romance De L'amour	EB
40	My Wild Irish Rose	EB

# Lesson Function

The Lesson function allows budding pianists to practice the piano using a selection of built-in song books. The left and right hand parts for each piece can be practiced separately, while adjusting the tempo allows difficult passages to be perfected.

For a complete listing of available Lesson Function songs, please refer to page 52 of this owner's manual.

## ■ Built-in lesson function song books

	US, Canada, Australasia	Rest of the World
Book 1	Alfred's Basic Piano Library Lesson Book Level 1A	Beyer 106 (Vorschule im Klavierspiel, Opus 101)
Book 2	Alfred's Basic Piano Library Lesson Book Level 1B	Burgmüller 25 (25 Etudes Faciles, Opus 100)
Book 3	Beyer 106 (Vorschule im Klavierspiel, Opus 101)	Czerny 30 (Etudes de Mécanisme, Opus 849)
Book 4	Burgmüller 25 (25 Etudes Faciles, Opus 100)	Alfred's Basic Piano Library Lesson Book Level 1A
Book 5	Czerny 30 (Etudes de Mécanisme, Opus 849)	Alfred's Basic Piano Library Lesson Book Level 1B

\* Lesson books sold separately - please refer to page 53 of this owner's manual for more information.

## 1 Selecting a lesson book/song

### 1. Entering lesson mode

Press the LESSON button.

The LED indicator for the LESSON button will turn on, indicating that lesson mode is enabled, and the SK Concert Grand sound will be selected automatically.

LESSON



### 2. Selecting a lesson book

Operation Guide: LESSON (page 16)

While holding down the LESSON button, press the black key assigned to the desired lesson book.

### 3. Selecting a lesson song

Operation Guide: LESSON (page 16)

While holding down the LESSON button, enter the piece number by pressing the corresponding white keys in sequence (e.g. to select piece no.25, press D1 followed by G1). Then, release the LESSON button.

\* The Lesson song number will be shown in the LED display.

## ■ Selecting the Beyer variation

The Beyer lesson book includes 106 exercises. Exercise no.1 consists of 12 variations, while exercise no.2 consists of 8 variations.

To select the variation for the no.1 and no.2 exercises, first press and hold the LESSON button and press the corresponding black key to select the Beyer lesson book.

While holding down the LESSON button, press the C1 or D1 key to select the no.1 or no.2 exercise, then finally press the B0 key (+) multiple times to select the desired variation.

### Listing of Beyer's pieces

No. 1	Theme
1-1 to 1-12	Variations
No. 2	Theme
2-1 to 2-8	Variations
No. 3	Theme
No. 4	Theme
↓	Theme
No. 106	Theme

## 2 Listening to the selected lesson song

This page will explain how to play and stop the selected lesson song, and adjust the tempo.

### ■ Playing the lesson song

After selecting a lesson book and song:

Press the PLAY/STOP button.

The LED indicator for the PLAY/STOP button will turn on, and a one bar count-in will be heard before the song starts to play.

While the lesson song is playing, press the METRONOME button to turn the metronome on/off.

\* The metronome time signature and tempo will automatically be set to that of the currently selected lesson song.

PLAY/  
STOP



METRO-  
NOME



### ■ Adjusting the tempo of the lesson song

Operation Guide: METRONOME (page 14~15)

While the lesson song is playing:

Press and hold the METRONOME button, enter the desired tempo using the lowest 12 white keys, then release the METRONOME button.

\* The lesson song tempo can be adjusted within the range of 10~300 bpm.

\* The lesson song tempo can be entered precisely, or decreased and increased gradually.

#### Method 1:

While pressing the METRONOME button, press keys 1, 5, and 0 to set the tempo to 150 bpm, or keys 0, 8 and 5 to set the tempo to 85 bpm.

#### Method 2:

While pressing the METRONOME button, press the - / + keys repeatedly to gradually decrease or increase the tempo in 2 bpm increments.

### ■ Stopping the lesson song

While the lesson song is playing:

Press the PLAY/STOP button again to stop the lesson song.

The LED indicator for the PLAY/STOP button will turn off.

PLAY/  
STOP



## 3 Practicing left and right-hand parts separately

This page will explain how to mute/activate the left and right-hand parts of the selected lesson song, allowing each part to be practiced separately.

The LED indicators for the METRONOME and SOUND SELECT buttons are used to indicate which part (left or right-hand) of the selected lesson song is muted/active.

METRONOME button LED	SOUND SELECT button LED	Lesson song playback
On	On	Left and Right-hand parts (default playing mode)
On	Off	Left-hand part only
Off	On	Right-hand part only

### ■ Muting/activating lesson song parts 1

After selecting a lesson book and song:

Press the SOUND SELECT button.

The LED indicator for the SOUND SELECT button will turn off (the LED indicator for the METRONOME button will remain turned on), indicating that only the left-hand part of the lesson song is active (i.e. the right-hand part will be muted).

**Press once:**  
Left-hand only

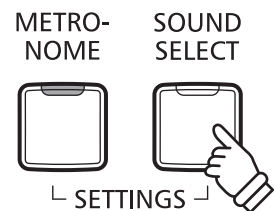

Press the SOUND SELECT button again.

The LED indicator for the SOUND SELECT button will turn on and the LED indicator for the METRONOME button will turn off, indicating that only the right-hand part of the lesson song is active (i.e. the left-hand part will be muted).

**Press twice:**  
Right-hand only

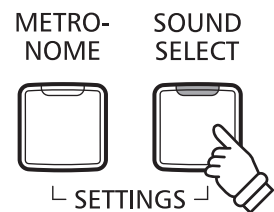

Press the SOUND SELECT button once again.

The LED indicator for the SOUND SELECT button will remain turned on and the LED indicator for the METRONOME button will also turn on, indicating that both the left and right-hand parts of the lesson song are active.

**Press 3 times:**  
Left and Right-hand

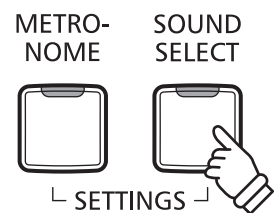

## ■ Muting/activating lesson song parts 2

Select a part directly. While holding down the LESSON button, press the part button you want to replay.

To restore the normal replay, exit the lesson mode and then enter the lesson mode again.

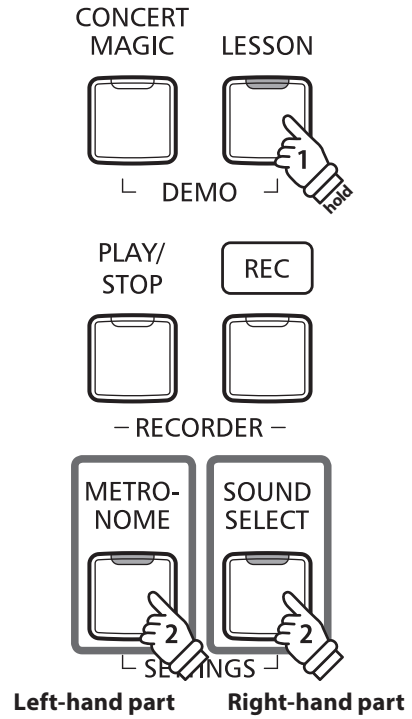

## ■ Exiting lesson mode

Press the LESSON button.

The LED indicator for the LESSON button will turn off, and the instrument will return to normal operation.

LESSON



# Recorder

The CN27 digital piano allows up to 3 different songs to be recorded, stored in internal memory, and played back at the touch of a button.

## 1 Recording a song

### 1. Entering song recorder mode

Press the REC button.

The LED indicator for the REC button will start to flash, to indicate that the piano is in recording standby mode.



### 2. Selecting a song memory

Operation Guide: RECORDER (page 16)

Press and hold the REC button, then press one of the lowest three white keys to select the desired song memory.

- \* Selecting a Recorder song memory that has already been used to record a song will automatically erase the previously recorded song.
- \* The Recorder song memory number will be shown in the LED display.

### 3. Starting the song recorder

Press a key on the keyboard.

The LED indicators for the REC and PLAY/STOP buttons will turn on, and recording will start.

- \* Recording can also be started by pressing the PLAY/STOP button, allowing a rest period or empty bar to be inserted at the beginning of the song.

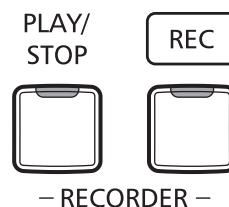

### 4. Stopping the song recorder

Press the PLAY/STOP button.

The LED indicators for the PLAY/STOP and REC buttons will flash briefly, and the song will be stored in internal memory.

- \* Do not turn the power off while the song is saving to memory.
- \* The maximum recording capacity is approximately 10,000 notes, with button and pedal presses also counted as some notes. If the maximum recording capacity is reached during recording, the recorder will stop automatically.
- \* Recorder songs will remain in memory after the power is turned off.

To prevent data loss when turning off the instrument, do not disconnect the power cable until **bye** is shown in the LCD display.



## 2 Playing back a song

### 1. Playing the recorded song

Press the PLAY/STOP button.

The LED indicator for the PLAY/STOP button will turn on, and the recorded song will start to play.

\* The Recorder song memory number will be shown in the LED display.

PLAY/  
STOP



### 2. Playing a song stored in another memory

Operation Guide: RECORDER (page 16)

Press and hold the PLAY/STOP button, then press one of the lowest three white keys to play the desired song memory.

\* The selected song will start to play when the PLAY/STOP button is released.

## 3 Erasing recorded songs



**Warning:** This process will erase all three songs stored in internal memory, and cannot be undone.

### ■ Erasing the recorder songs

Press and hold the PLAY/STOP and REC buttons simultaneously, then turn the instrument's power on.

All recorder songs stored in memory will be erased.

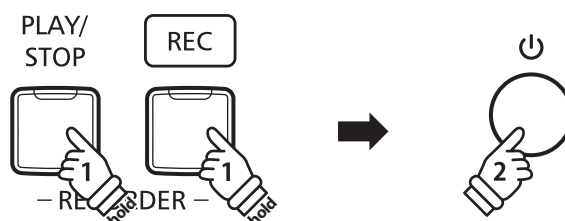

# Keyboard and Sound Settings

The CN27's keyboard and sound settings allow various aspects of the instrument to be adjusted.

## ■ Keyboard and Sound Settings

Setting name	Description	Default setting
Reverb	Change the type of reverberation added to the sound.	On
Brilliance	Adjust the brightness of the sound.	0
Tuning	Increase or decrease the pitch of the keyboard in 0.5 Hz steps.	440.0Hz
Transpose	Increase or decrease the pitch of the keyboard in semi-tone steps.	0
Touch	Change the touch sensitivity of the keyboard.	Normal
Virtual Technician	Select the tuning from 10 preset styles.	Off
Spatial Headphone Sound	Select the desired Spatial Headphone Sound mode.	Normal
Phones Type	Select the type of headphones to be used with the instrument.	Normal

## 1 Reverb

The Reverb setting adds reverberation to the sound, simulating the acoustic environment of a recital room, stage, or concert hall. The most suitable reverb type is applied automatically when selecting each sound, however it is also possible to select a different reverb type manually if desired.

### ■ Reverb type

Reverb type	Description	Key
Off	Disables the reverb effect.	B2
Room	Simulates the ambiance of a small rehearsal room.	C3
Lounge	Simulates the ambiance of piano lounge.	D3
Small Hall	Simulates the ambiance of a small hall.	E3
Concert Hall	Simulates the ambiance of a concert hall or theater.	F3
Live Hall	Simulates the ambiance of a live hall or stage.	G3
Cathedral	Simulates the ambiance of a large cathedral.	A3

### ■ Changing the Reverb type

Operation Guide: SOUND (page 12~13)

Press and hold the SOUND SELECT button, then press the key assigned to the desired Reverb type.

\* The Reverb setting will be shown in the LED display.

## 2 Brilliance

The Brilliance setting allows the brightness of the CN27 digital piano's sound to be adjusted.

### ■ Adjusting the Brilliance setting

Operation Guide: SOUND (page 12~13)

Press and hold the SOUND SELECT button, then press the F#5 or G#5 keys repeatedly to decrease or increase the brightness of the sound.

- \* The Brilliance setting can be adjusted within the range of -10~+10, with +10 being the brightest setting.
- \* To reset the Brilliance effect, press the C#5 key.
- \* The Brilliance setting will be shown in the LED display.

## 3 Tuning

The Tuning setting allows the overall pitch of the CN27 digital piano to be raised and lowered in 0.5 Hz steps, and may therefore prove useful when playing with other instruments.

### ■ Adjusting the Tuning setting

Operation Guide: SETTINGS (page 14~15)

Press and hold the METRONOME and SOUND SELECT buttons, then enter the desired pitch using the number keys. Press and hold the METRONOME and SOUND SELECT buttons, then press the keys assigned -/+ to lower or raise the keyboard pitch in 0.5 Hz steps.

- \* The Tuning setting can be adjusted within the range of 427~453 Hz.
- \* To reset the Tuning setting to 440.0Hz, press the A#0 key.
- \* The Tuning setting will be shown in the LED display.

## 4 Transpose

The Transpose setting allows the pitch of the CN27 digital piano keyboard to be raised or lowered in semi-tone steps. This is particularly useful when accompanying instruments with different tones, or when a song learned in one key must be played in another key. When transposed, the song can be played in the original key, yet heard in a different key.

### ■ Adjusting the Transpose setting

Operation Guide: SETTINGS (page 14~15)

Press and hold the METRONOME and SOUND SELECT buttons, then press the C#2 or D#2 keys repeatedly to lower or raise the keyboard pitch in semi-tone steps.

- \* The Transpose setting can be adjusted within the range of -6~+5 semi-tones.
- \* To disable or re-enable the Transpose, press the G#1 or A#1 keys.
- \* The Transpose setting will be shown in the LED display.

# 5 Touch

As with an acoustic piano, the CN27 digital piano produces a louder sound when the keys are struck with force, and a softer sound when the keys are played gently. The volume and tonal character change in relation to the strength and speed of playing - on a digital piano this system is referred to as 'touch sensitivity'.

The Touch setting allows the touch sensitivity of the keyboard to be conveniently adjusted. There are four different preset touch settings available.

### ■ Touch type

Touch type	Description	Key
Off	A constant volume is produced regardless of how hard the keys are struck. This setting is recommended for sounds that have a fixed dynamic range such as organ and harpsichord.	C5
Light	A louder volume is produced even when playing with a soft touch. This setting is recommended for children and organ players, or for those still developing finger strength.	
Normal (default)	Reproduces the standard touch sensitivity of an acoustic piano.	
Heavy	Requires a heavier touch to produce a loud volume. This setting is recommended to those with stronger fingers.	

### ■ Changing the Touch type

Operation Guide: SOUND (page 12~13)

Press and hold the SOUND SELECT button, then press the C5 key to cycle through the different Touch types in order.

\* The Touch setting will be shown in the LED display.

## 6 Virtual Technician (Smart Mode)

An experienced piano technician is essential to fully realise the potential of a fine acoustic piano. In addition to meticulously tuning each note, the technician also performs numerous regulation and voicing adjustments that allow the instrument to truly sing.

The CN27 digital piano's Virtual Technician simulates these refinements digitally, with ten preset configurations that intelligently adjust various characteristics of the grand piano sound to match different musical styles.

\* If the Sound Preview function is enabled, a short passage will be played after selecting each Virtual Technician type.

\* The preferred Virtual Technician present can be stored to memory using the Startup Setting function. Please refer to page 39 for more information.

### ■ Virtual Technician type

Virtual Technician type	Description	Key
Off (default)	The default piano sound without additional adjustments.	C4
Noiseless	A piano adjusted to minimise additional damper, string, and cabinet resonances, and mechanism noises.	D4
Deep Resonance	A piano adjusted to emphasise damper, string, and cabinet resonances.	E4
Less Resonance	A piano adjusted to reduce damper, string, and cabinet resonances.	F4
Soft	A piano adjusted by softening the hammers and increasing the touch weight of the keyboard in order to produce a softer tone that is suitable for slow, quiet pieces.	G4
Brilliant	A piano adjusted by hardening the hammers in order to produce a brighter tone for modern pieces.	A4
Clean	A piano adjusted by hardening the hammers and reducing the damper, string, and cabinet resonances.	C#4
Strong	A piano adjusted to emphasise dynamics with a lightened keyboard touch and powerful damper, string, and cabinet resonances.	D#4
Dark	A piano adjusted by hardening the hammers and increasing the touch weight of the keyboard, in order to produce a dark, gloomy tone.	F#4
Rich	A piano adjusted by lightening the touch weight of the keyboard and increasing damper, string, and cabinet resonances.	G#4
Classical	A piano adjusted for romantic, classical music, with a bright, open tone.	A#4

### ■ Selecting the Virtual Technician type

Operation Guide: SOUND (page 12~13)

Press and hold the SOUND SELECT button, then press the key assigned to the desired Virtual Technician type.

\* For the name and display indication of each setting, refer to page 12~13 Operation Guide SOUND.

### ■ Virtual Technician Advanced Mode (iPad app)

In addition to changing the piano's sound by selecting different Virtual Technician presets, it is also possible to adjust individual characteristics using the dedicated Virtual Technician iPad app. This app gives the player full control over every aspect of the piano's configuration, allowing precise adjustments to be made to voicing, string and damper resonance, action regulation, and various other acoustic characteristics, from a convenient touchscreen interface.

\* For more information about the Virtual Technician iPad app, please visit the AppStore: <https://itunes.apple.com/app/id948579667>

## 7 Spatial Headphone Sound

Spatial Headphone Sound is a special feature of the CN27 digital piano that enhances the depth and realism of the acoustic piano sound when listening through headphones or earphones.

The Spatial Headphone Sound setting allows the player to select from one of three different acoustic presets that adjust the spatial positioning of the sound, while also helping to reduce auditory fatigue when using earphones or headphones for extended periods of time.

### ■ Spatial Headphone Sound type

Spatial Headphone Sound type	Description	Key
Off	Disable the Spatial Headphone Sound feature.	C#7
Forward	Front focused, somewhat narrow spatial positioning.	F#7
Normal (default)	Naturally balanced spatial positioning that is neither forward nor wide.	G#7
Wide	Wide, very open spatial positioning.	A#7

### ■ Setting the Special Headphone Sound system

Operation Guide: SOUND (page 12~13)

Press and hold the SOUND SELECT button, then press the key assigned to the desired Spatial Headphone Sound type.

\* The Spatial Headphone Sound setting will be shown in the LED display.

## 8 Phones Type

The Phones Type setting optimises the sound of the CN27 digital piano when listening through different types of headphones or earphones.

\* This setting does not affect the speaker sound.

### ■ Phones type

Phones type	Description	Key
Normal (default)	Disables headphone optimisation.	C7
Open	Optimises the sound for open type headphones.	D7
Semi-open	Optimises the sound for semi-open type headphones.	E7
Closed	Optimises the sound for closed type headphones.	F7
Inner-ear	Optimises the sound for inner-ear type headphones.	G7
Canal	Optimises the sound for canal-type headphones	A7

### ■ Phones Type setting

Operation Guide: SOUND (page 12~13)

Press and hold the SOUND SELECT button, then press the key assigned to the desired Phones type.

\* The Phones Type setting will be shown in the LED display.

# Startup Settings

The Startup Settings function allows preferred panel settings to be stored in the instrument's memory, and automatically recalled as the default settings every time the CN27 digital piano is turned on.

## ■ Settings stored in Startup Settings

Selected Sound	Keyboard and Sound Settings
Dual Mode / Four Hands Mode Settings	Virtual Technician Settings
Metronome (Beat, Tempo, Volume)	MIDI Settings

## ■ Storing Startup Settings

Press and hold the SOUND SELECT and REC buttons simultaneously for three seconds.

The LED indicators for the METRONOME, PLAY/STOP, and CONCERT MAGIC buttons will turn on sequentially, then flash to indicate that the Startup Settings have been stored.

\* **SPE** will be shown in the LED display.

To prevent data loss when turning off the instrument, do not disconnect the power cable until **b4E** is shown in the LCD display.



Press and hold the buttons for three seconds

# Auto Power Off

The CN27 digital piano features a power saving function that can be used to automatically turn off the instrument after a specified period of inactivity.

\* This setting will be stored automatically, and recalled every time the instrument is turned on.

## ■ Auto Power Off settings

Auto Power Off	Description
Off	The Auto Power Off function is disabled.
15 min.	The instrument will turn off automatically after 15 minutes of inactivity.
60 min.	The instrument will turn off automatically after 60 minutes of inactivity.
120 min.	The instrument will turn off automatically after 120 minutes of inactivity.

## ■ Selecting the Auto Power Off setting

Operation Guide: SETTINGS (page 14~15)

Press and hold the METRONOME and SOUND SELECT buttons simultaneously, then press the key assigned to the desired Auto Power Off setting.

\* The Auto Power Off setting will be stored automatically, and recalled every time the instrument is turned on.

\* The Auto Power Off setting will be shown in the LED display.

# Bluetooth® MIDI

The Bluetooth MIDI setting is used to enable/disable the CN27 digital piano's Bluetooth MIDI function. When enabled, the CN27 digital piano can be connected to smart phones, tablets, and other smart devices to facilitate wireless MIDI communication, allowing a wide range of music-related apps to be enjoyed using the instrument.

\* Availability of Bluetooth function dependent on market location.

## ■ Bluetooth MIDI settings

Bluetooth MIDI	Description	Key
Off	Disables the instrument's Bluetooth MIDI function.	G#5
On (default)	Enables the instrument's Bluetooth MIDI function.	A#5

## ■ Enabling/disabling Bluetooth MIDI

Operation Guide: SETTINGS (page 14~15)

Press and hold the METRONOME and SOUND SELECT buttons, then press the G#5 key to disable Bluetooth MIDI, or the A#5 key to enable Bluetooth MIDI.

\* The Bluetooth MIDI setting will be shown in the LED display.

## ■ Connecting the CN27 digital piano to a smart device using Bluetooth MIDI

After enabling the Bluetooth MIDI function of the CN27 digital piano, enable Bluetooth communications on the smart device. After a few moments the CN27 should appear in the device list. Tap the CN27 entry to connect the instrument to the smart device. It should now be possible for MIDI apps to communicate with the CN27 digital piano.

\* When the CN27 digital piano is connected to a smart device via Bluetooth MIDI, the USB MIDI and MIDI IN/OUT connectors will be disabled.

\* Please check for Bluetooth MIDI compatibility with the smart device manufacturer and app developer.

\* For a list of potential issues and recommended solutions when using Bluetooth communications, please refer to page 44 of this owner's manual.

\* For more detailed instructions regarding Bluetooth pairing, please refer to the supplementary Bluetooth® Connectivity Guide PDF manual, available from the Kawai Japan website: <http://www.kawai-global.com/support/manual/>

# Sound Preview/Vocal Assist Volume

This function is used to adjust the volume of the Sound Preview and Vocal Assist features.

The volume can be set to one of three levels, or silenced completely.

## ■ Setting the Sound Preview/Vocal Assist volume

Operation Guide: SETTINGS (page 14~15)

Press and hold the METRONOME and SOUND SELECT buttons simultaneously, then press the G#7 or A#7 keys to decrease or increase the volume of the Sound Preview/Vocal Assist feature.

\* The volume can be set to 0 (Off)~3.

\* This setting will be stored automatically, and recalled every time the instrument is turned on.

\* The factory default volume level is 2.

\* The Sound Preview/Vocal Assist Volume setting will be shown in the LED display.



# Vocal Assist On/Off

This function is used to enable/disable the Vocal Assist function.

## ■ Turning Vocal Assist On/Off

Press and hold the SOUND SELECT button, then press the instrument's POWER button.

The Vocal Assist function will turn On/Off.

\* This setting will be stored automatically, and recalled every time the instrument is turned on.

\* The factory default setting is Off.

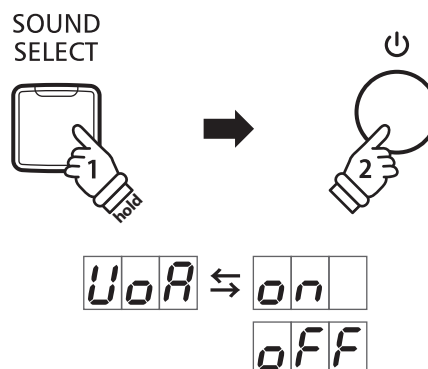

# Factory Reset

The Factory Reset function clears any settings stored using the Startup Settings function, or Auto Power Off, Sound Preview Volume, Vocal Assist On/Off, and User Key Volume settings, restoring the CN27 digital piano back to its factory default configuration.

## ■ Restoring factory settings

Press and hold the METRONOME and SOUND SELECT buttons simultaneously, then turn the power on.

The LED indicators for all the buttons will start to flash.

Turn the CN27 digital piano off and then on.

The CN27 digital piano will be restored to its factory default setting.

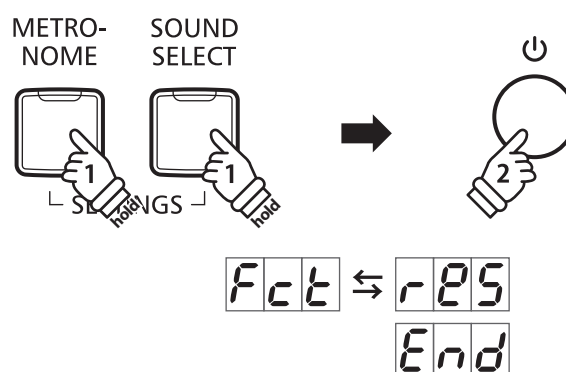

# Connecting to Other Devices

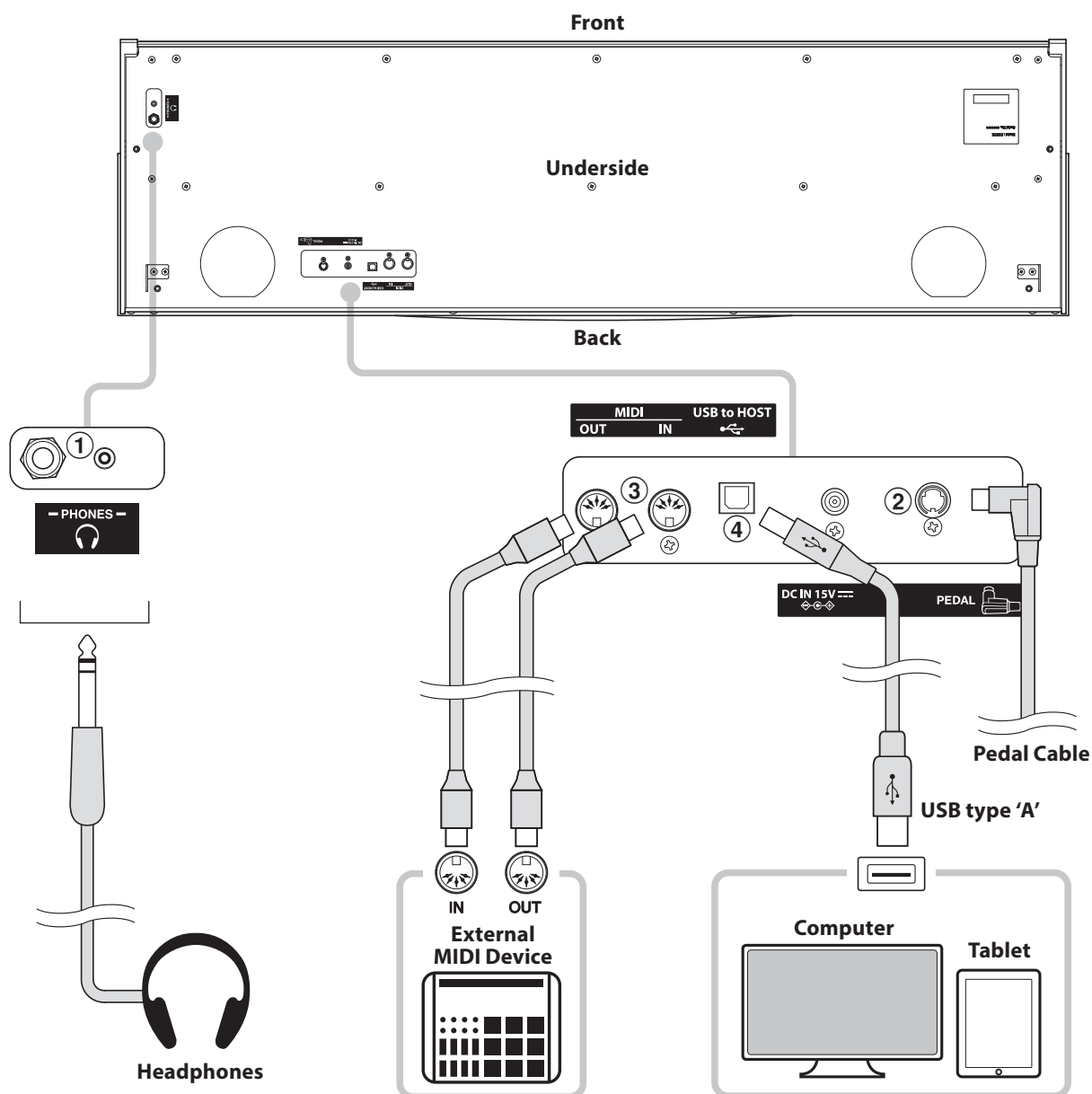

## ① PHONES jacks (1/4" & 1/8" phone jacks)

These jacks are used to connect stereo headphones to the CN27 digital piano. Headphones can be connected and used simultaneously. When a pair of headphones is connected, sound will not be produced by the speakers.

## ② PEDAL connector

This connector is used to connect the pedal board to the CN27 digital piano (see page 50).

## ③ MIDI IN/OUT jacks

These jacks are used to connect the CN27 digital piano to external MIDI devices, such as a sound module, or a computer with a MIDI interface.

## ④ USB to Host port ('B' type)

This port is used to connect the CN27 digital piano to a computer using an inexpensive USB cable. When connected, the instrument can be used as a standard MIDI device, allowing it to send and receive MIDI data. Connect a 'B' type USB connector to the instrument, and an 'A' type USB connector to the computer.

With additional conversion adaptors, this port may also be used to connect the CN27 digital piano to tablets such as the Apple iPad and other mobile devices.

# USB MIDI (USB to Host connector)

The CN27 digital piano features a 'USB to Host' type connector, allowing the instrument to be connected to a computer using an inexpensive USB cable and utilised as a MIDI device. Depending on the type of computer and operating system installed, additional driver software may be required for USB MIDI communication to function correctly.

## ■ USB MIDI driver

Operating System	USB MIDI Driver Support
Windows Vista (SP1, SP2) Windows Vista 64-bit (SP1, SP2) Windows 7 Windows 7 64-bit Windows 8 Windows 8 64-bit Windows 8.1 Windows 8.1 64-bit Windows 10 Windows 10 64-bit	The standard (built-in) Windows USB-MIDI driver is used. This driver will be installed automatically when the instrument is connected to the computer. To enable MIDI communication between the application software and the instrument, select "USB-MIDI" as a MIDI device.
Windows Vista (no SP) Windows Vista 64-bit (no SP)	USB-MIDI is not supported. Please upgrade to Service Pack 1 or Service Pack 2.
Windows 98 SE Windows 2000 Windows ME Windows XP (no SP, SP1, SP2, SP3) Windows XP 64-bit	Windows XP or earlier versions are not supported. Please use a third-party MIDI interface for MIDI connection.
Mac OS X	<b>Additional USB MIDI driver software NOT required.</b> The standard (built-in) Mac OS X USB MIDI driver will be installed automatically when the instrument is connected to the computer.
Mac OS 9	<b>USB MIDI is not supported.</b> Please use the standard MIDI IN/OUT connectors.

## ■ USB MIDI information

- If the instrument's MIDI IN/OUT jacks and USB MIDI port are both connected simultaneously, the USB MIDI port will be given priority.
- Ensure that the instrument is turned OFF before attempting to connect the USB MIDI cable.
- When connecting the instrument to a computer using the USB MIDI port, there may be a short delay before communications begin.
- If the instrument is connected to a computer via a USB hub and USB MIDI communication becomes unreliable/unstable, please connect the USB MIDI cable directly to the one of the computer's USB ports.
- Disconnecting the USB MIDI cable suddenly, or turning the instrument on/off while using USB MIDI may cause computer instability in the following situations:
  - while installing the USB MIDI driver
  - while starting up the computer
  - while MIDI applications are performing tasks
  - while the computer is in energy saver mode
- If there are any further problems experienced with USB MIDI communication while the instrument is connected, please double-check all connections and relevant MIDI settings in the computer's operating system.

\* 'MIDI' is a registered trademark of the Association of Manufacturers of Electronic Instruments (AMEI).

\* 'Windows' is registered trademark of Microsoft Corporation.

\* 'Macintosh' and 'iPad' are registered trademark of Apple Computer, Inc.

\* Other company names and product names mentioned referenced herein may be registered trademarks or trademarks of respective owners.

\* Bluetooth® word marks and logos are registered trademarks owned by Bluetooth SIG, Inc. Kawai uses these marks and logos under the license. Other trademarks and trade names belong to their respective owners.

\* Bluetooth (Ver 4.1 GATT compatible) / Bluetooth Low Energy MIDI Specification is supported.

# Troubleshooting

	Problem	Possible Cause and Solution	Page no.
Power	The instrument does not turn on.	Check that the power cable is firmly attached to the instrument, and connected to an AC outlet.	p. 11
	The instrument turns itself off after a period of inactivity.	Check that the 'Auto Power Off' function is not enabled.	p. 39
Sound	The instrument is turned on, however no sound is produced when the keys are played.	Check that the MASTER VOLUME slider is not set to the lowest position.	p. 11
		Check that a pair of headphones (or headphone adaptor plug) are not connected to the PHONES jack.  Check that Local Control is enabled in the MIDI Settings menu.	p. 11  "MIDI Settings Manual" p. 4
	The sound distorts when playing at very loud volume levels.	Check that the MASTER VOLUME slider is set to an appropriate level, reducing the volume if excessive distortion is heard.	p. 11
	The pitch or sound quality with a specific piano timbre is odd.	The CN27 digital piano attempts to reproduce the rich variety of tones created by an acoustic grand piano as accurately as possible. This includes damper resonances and other subtle effects that contribute to the overall piano playing experience.  While these additional effects are intended to enhance the realism of the instrument, it is possible to reduce their prominence, or disable them altogether using the sound settings.	p. 34 p. 37
Pedals	The pedals are unreliable or do not function at all.	Check that the pedal cable is firmly connected to the instrument.	p. 50
	When depressing a pedal, the pedal board flexes and is not firm.	Check that the pedal support bolt is fully extended.	p. 11
	The top 18 notes of the keyboard sustain for longer than neighbouring notes, even when the damper pedal is not pressed.	This is the correct behaviour, and intended to reproduce the undamped notes (typically the top two octaves) of an acoustic grand piano.	—
	The instrument produces a 'swoosh' sound when the damper pedal is pressed.	The CN27 digital piano reproduces the sound of dampers on a grand piano touching and releasing the strings. If this intentional sound is undesirable, it may be prevented by selecting the 'Noiseless' Virtual Technician preset, or by reducing the 'Damper Noise' parameter using the Virtual Technician iPad app. This sound can also be silenced by pressing and holding the SOUND SELECT and METRONOME buttons, then pressing the F#7 key.	p. 37
USB MIDI, MIDI, Bluetooth® MIDI	The instrument is connected to the computer using a USB cable (or a USB-MIDI adaptor), however the software does not respond to key presses.	Check that a USB MIDI driver is installed on the computer.	p. 43
		Check that 'USB Audio Device' or 'KAWAI USB MIDI' is selected in the software's input/output device settings.  Check that the instrument is not connected to a smart device using Bluetooth MIDI.	p. 43 p. 40
	The instrument cannot connect to the smart device/app via Bluetooth.	Check that the instrument's Bluetooth MIDI function is turned On.	p. 40
		Ensure that the mobile device's Bluetooth function is turned On.  Try deleting the instrument's Bluetooth connection using the mobile device's 'Forget Device' function.  Try turning the instrument Off and then On, and/or restarting the mobile device.	
Keyboard	The volume level is different between piano keys.	Try using the User Key Volume setting to adjust the volume of the key(s) that are too quiet or too loud.	p. 45

# User Key Volume

The User Key Volume settings allow the volume of each of the 88-keys to be adjusted individually.

## ■ Entering the User Key Volume setting

Press and hold the CONCERT MAGIC and LESSON buttons simultaneously, then turn the instrument's power off/on.

The LED indicator for the CONCERT MAGIC, LESSON, PLAY/STOP and REC buttons will turn on.

While the User Key Volume setting is selected, the keys of the CN27 digital piano can no longer be played for ordinary musical performance.

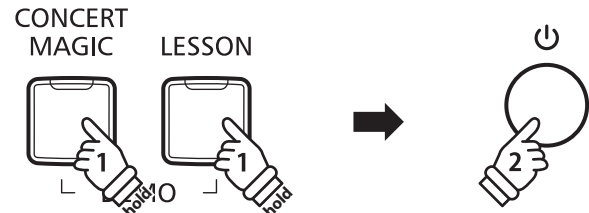

## ■ Selecting the note, adjusting the User Key Volume

Press the desired key to select it for volume adjustment.

Press the SOUND SELECT button to increase the User Key Volume value for the selected key.

Press the METRONOME button to decrease the User Key Volume value for the selected key.

Press the selected key to check its adjust volume.

\* The User Key Volume value can be adjusted within the range of -50~+50.

\* To reset the currently selected key to its default User Key Volume value, press the SOUND SELECT and METRONOME buttons simultaneously.

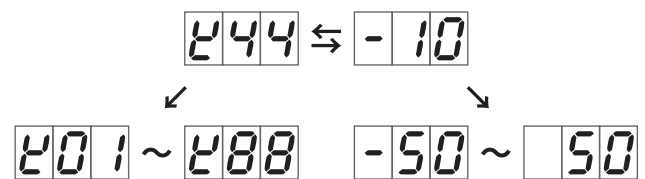
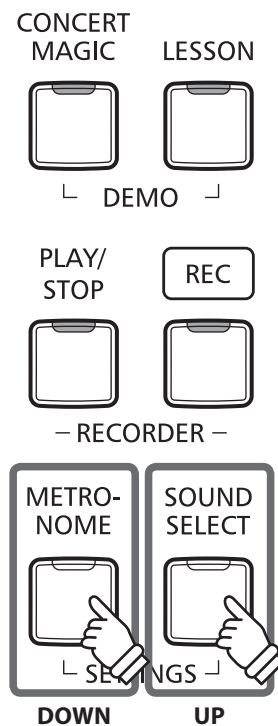

## ■ Resetting the User Key Volume setting

Press the CONCERT MAGIC, LESSON, PLAY/STOP, and REC buttons simultaneously.

The LED indicators for the CONCERT MAGIC, LESSON, PLAY/STOP, and REC buttons will start to flash, and the volume values of all 88 keys will be initialized.

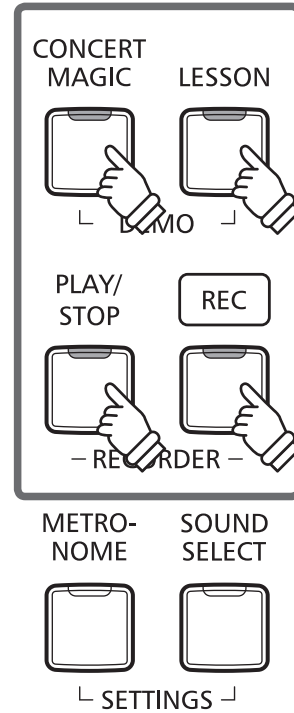

## ■ Exiting the User Key Volume setting

Turn the instrument's power off.

\* This setting will be stored automatically, and recalled every time the instrument is turned on.

# Assembly Instructions



Please read these assembly instructions thoroughly before attempting to assemble the CN27 digital piano.

Please ensure that two or more people work on assembling the CN27 digital piano, especially when lifting the main body of the instrument onto the stand.

## ■ Included parts

Before attempting to assemble the CN27 digital piano, ensure that all parts below are included. A Phillips-head screwdriver (not included) will also be required in order to assemble the instrument.

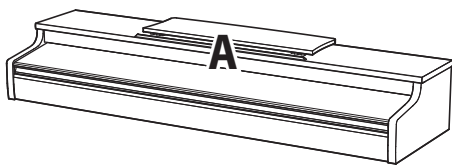

Main body

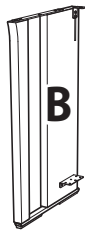

Side panel (left & right)

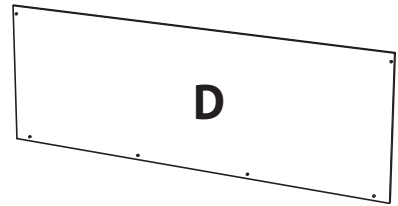

Back board



Pedal board  
(including adjuster bolt)

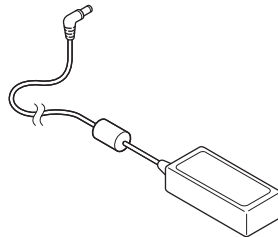

AC/DC adaptor

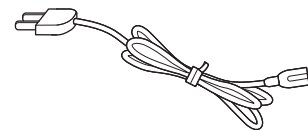

Power cable

### Screw set

- a** Screw (with flat washer and spring washer) x 4



- b** Tapping screw (long, black, 4 x 30 mm) x 2 \*



- c** Tapping screw (short, black, 4 x 20 mm) x 4 \*



- d** Tapping screw (silver, 4 x 16 mm) x 4

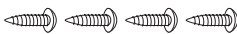

\* For Satin White finished instruments, black screws will be replaced with silver screws.

### Headphone hook set

Headphone hook



Mounting screw x 2  
(4 x 14 mm)



# Assembly Instructions

## 1. Attaching the side panels to the pedal board

- 1 Unfasten and extend the pedal connection cable attached to the bottom of the pedal board (E).
- 2 Attach the pedal board (E) to the left (B) and right (C) side panels using the temporary mounting screws located on either end of the pedal board.
- 3 Ensure that the pedal board and side panels make close contact, and that there are no large gaps between the assembled parts.
- 4 Insert the four short silver tapping screws **d** into the holes as shown, and securely fasten the pedal board to the left and right side panels.

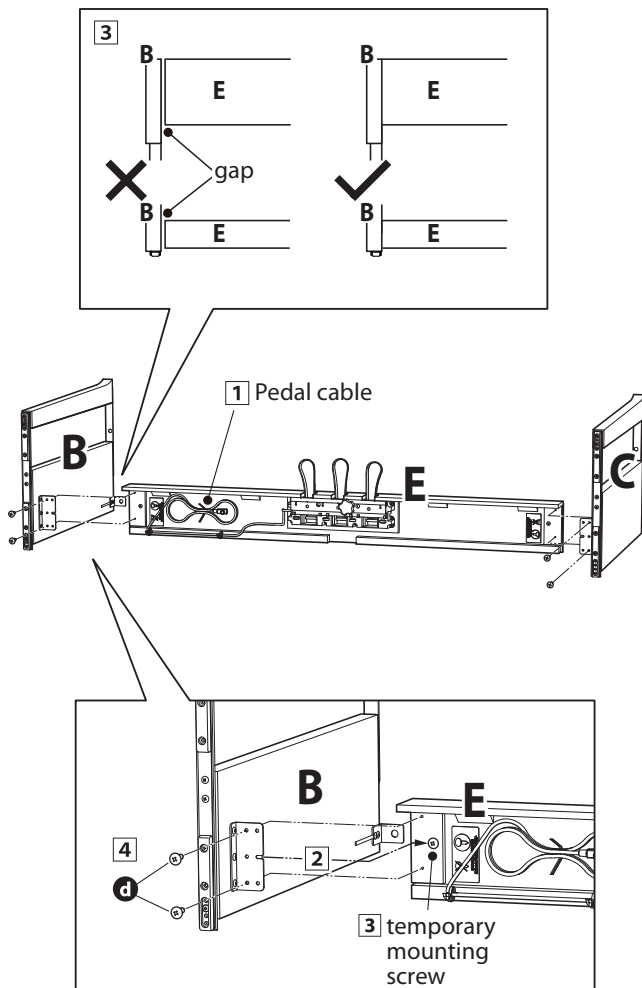

## 2. Attaching the back board

- 1 Allow the assembled pedal board and side panels to stand upright (vertically) on the floor.
  - \* Ensure that the adjustor bolt is attached to the pedal board.
- 2 Loosely attach the back board (D) to the left and right side panels using the four long black tapping screws **b**\*.
- 3 Loosely attach the bottom of the back board to the pedal board using the four mid-length black or silver tapping screws **c**\*.
- 4 Adjust the positioning of the pedal board, side panels, and backboard to ensure that all parts are in alignment, then tighten the screws in steps 2 and 3.

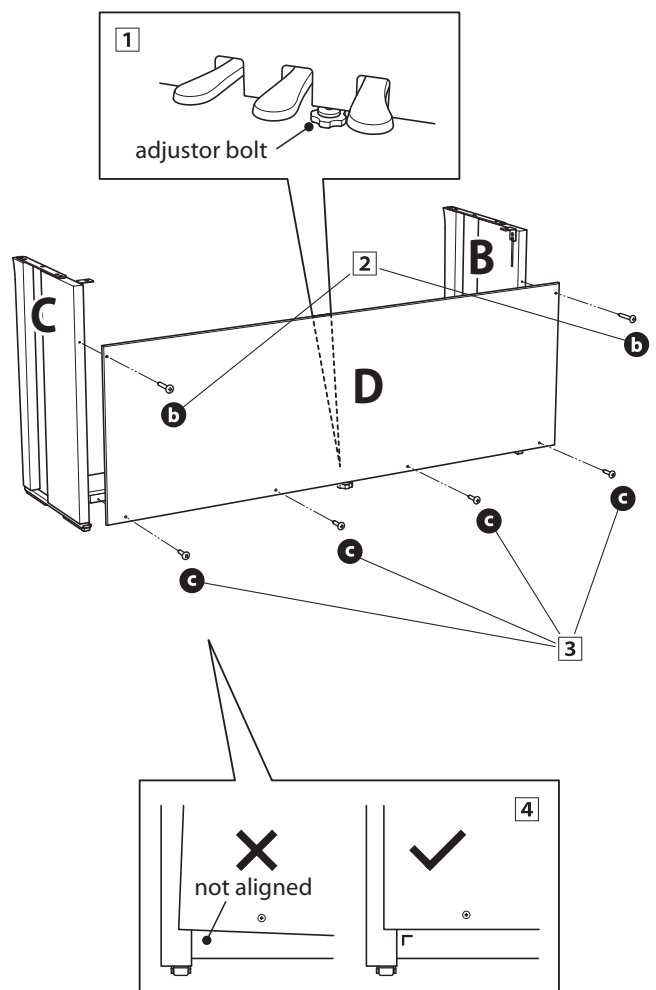

\* For Satin White finished instruments, black screws will be replaced with silver screws.



### 3. Mounting the main body onto the stand



Ensure that two or more people undertake the following step of the assembly process.

- 1 Lift the main body (A) and carefully place it onto the stand. Position the main body towards the front of the stand, so that the metal fitting holes are visible when viewed from above.
- 2 Gently slide the main body backwards until the base engages with the stand fixings and locks into place. When positioned correctly, the attachment screw holes should be visible from the underside of the main unit.

\* If the screw holes are not visible, re-adjust (loosen) the screws attached in step 2-4.



When lifting the main body onto the stand, be careful not to catch/trap hands and fingers.

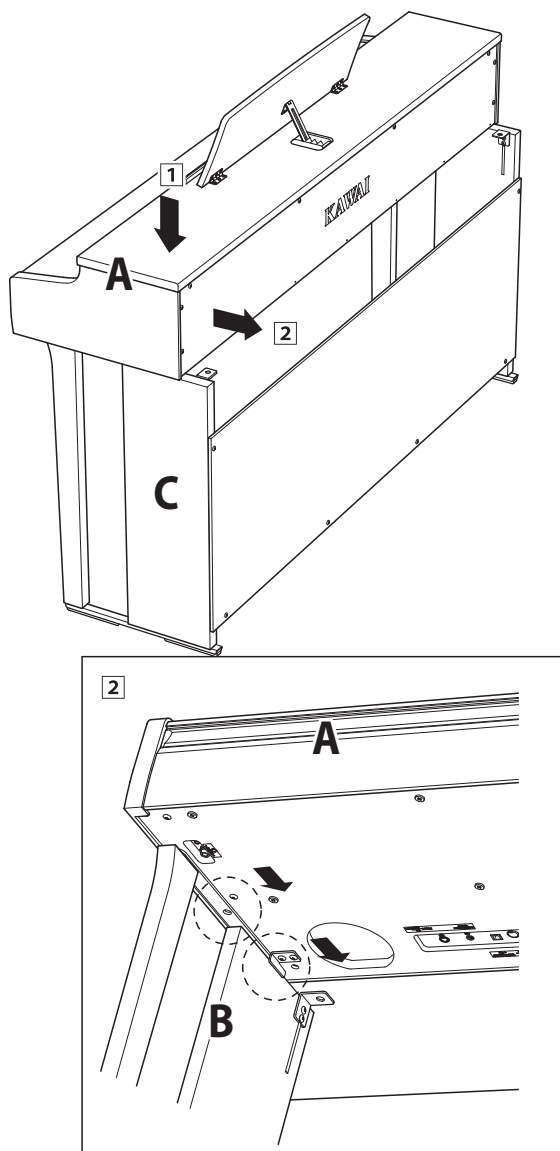

### 4. Fastening the main body to the stand

- 1 View the front of the instrument to ensure that the main body and side panels are in alignment.  
\* If the parts are not in alignment, re-adjust (loosen) the screws attached in step 2-1.
- 2 Loosely fasten the front of the main body to the stand from below, using two screws (with washer) (a) on either side.
- 3 Loosely fasten the rear of the main body to the stand from below, using the remaining two screws (with washer) (a) on either side.
- 4 When all four screws are attached and the main body is correctly positioned on top of the stand, securely tighten all screws.



Tighten all screws securely to ensure that the main body is firmly attached to the stand.

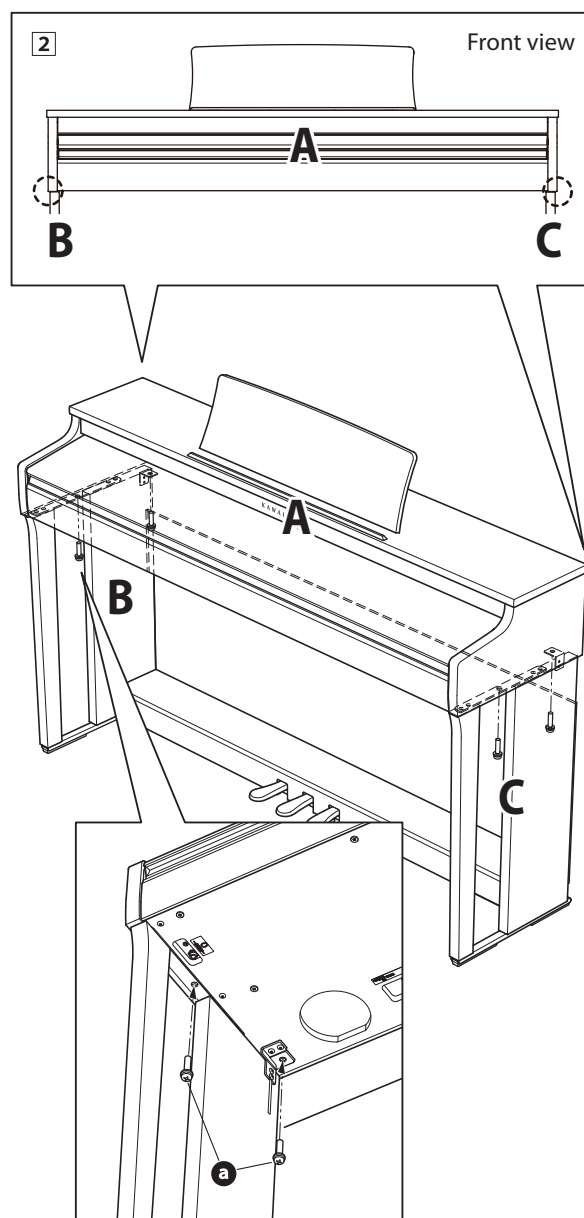

# Assembly Instructions

## 5. Connecting the power adaptor & pedal cables

- 1 Connect the AC/DC power adaptor to the DC IN terminal on the underside of the main body, then pass the cable through the back board aperture, and out to the rear of the instrument.
- 2 Pass the pedal cable (extending from the rear of the pedal board) through the aperture to the front of the main body, and connect to the PEDAL terminal.
- 3 With the power adaptor and pedal cables connected, use the binders to fix the cables in place and tidy their appearance.

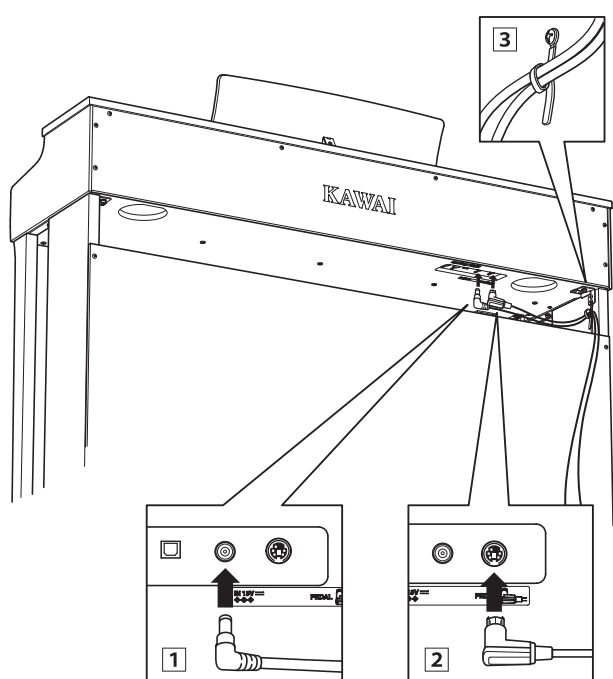

To avoid damaging the plugs or bending the pins, connect the plugs with the correct orientation, and do not apply excessive force when connecting.

## 6. Attaching the headphone hook (optional)

A headphone hook is included with the CN27 digital piano and can be used to hang headphones when not in use.

- 1 If desired, attach the headphone hook to the underside of the main body using the two tapping screws provided.

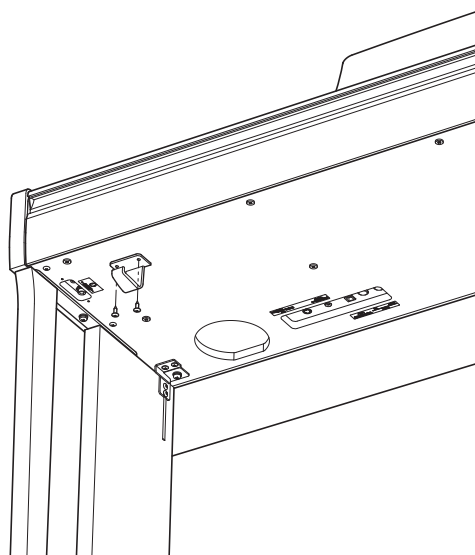

## 7. Adjusting the pedal support bolt

- 1 Turn the pedal support bolt anti-clockwise, extending the bolt until it makes contact with the floor and supports the pedals firmly.

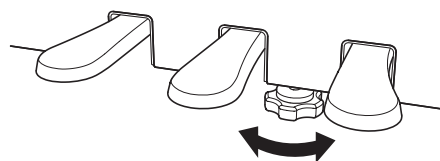

When moving the instrument, always adjust or remove the pedal support bolt, then readjust when the instrument is in its new position.

# Demo Song List

Sound Name	Song Title	Composer
SK Concert Grand	La Campanella	Liszt
EX Concert Grand	Hungarian Rhapsodies No.6	
Upright Piano	Alpenglühén Op.193	Oesten
Studio Grand	Original	
Studio Grand 2	Original	Kawai
Mellow Grand	Sonata No.30 Op.109	Beethoven
Mellow Grand 2	La Fille aux Cheveux de lin	Debussy
Modern Piano	Original	
Classic E.Piano	Original	
Modern E.Piano	Original	Kawai
Jazz Organ	Original	
Church Organ	Chorale Prelude "Wachet auf, ruft uns die Stimme."	
Harpsichord	French Suite No.6	Bach
Vibraphone	Original	Kawai
String Ensemble	Le quattro stagioni: la "Primavera"	Vivaldi
Slow Strings	Original	Kawai
Choir	Londonderry Air	Irish folk song
New Age Pad	Original	
Atmosphere	Original	Kawai

# Concert Magic Song List

Key	No.	Song name	Composer
A0	1	Twinkle, Twinkle, Little Star	French folk song
B0	2	I'm A Little Teapot	Traditional
C1	3	Mary Had A Little Lamb	American folk song
D1	4	London Bridge	Traditional
E1	5	Row, Row, Row Your Boat	American folk song
F1	6	Frère Jacques	French folk song
G1	7	Old MacDonald Had A Farm	American folk song
A1	8	Hark The Herald Angels Sing	Mendelssohn
B1	9	Jingle Bells	Traditional
C2	10	Deck The Halls	Welsh Air
D2	11	O Come All Ye Faithful	J.Reading
E2	12	Joy To The World	Traditional
F2	13	Silent Night	Traditional
G2	14	We Wish You A Merry Christmas	British folk song
A2	15	Battle Hymn Of The Republic	Traditional
B2	16	Yankee Doodle	American folk song
C3	17	Londonderry Air	Irish folk song
D3	18	Clementine	American folk song
E3	19	Auld Lang Syne	Scottish folk song
F3	20	Oh Susanna	S.C.Foster
G3	21	The Camptown Races	S.C.Foster
A3	22	When The Saints Go Marching In	American folk song
B3	23	The Entertainer	S.Joplin
C4	24	William Tell Overture	Rossini
D4	25	Andante from Symphony No.94 (Haydn)	Haydn
E4	26	Für Elise	Beethoven
F4	27	Clair De Lune	Debussy
G4	28	Skater's Waltz	E.Waldteufel
A4	29	Blue Danube Waltz	Strauss
B4	30	Gavotte (Gossec)	Gossec
C5	31	Waltz Of The Flowers	Tchaikovsky
D5	32	Bridal Chorus	Wagner
E5	33	Wedding March	Mendelssohn
F5	34	Pomp And Circumstance	Elgar
G5	35	When Irish Eyes Are Smiling	E.R.Ball
A5	36	Chiapanecas	Mexican folk song
B5	37	Santa Lucia	Naplish folk song
C6	38	Funiculi Funiculà	L.Denza
D6	39	Romance De L'amour	Spanish folk song
E6	40	My Wild Irish Rose	Chauncy Alcote

# Lesson Function Song Lists

No.	Alfred's Basic Piano Library Lesson Book Level 1A
1	Right & Left
2	Left & Right
3	Merrily We Roll Along/O'er the Deep Blue Sea
4	Hand-Bells
5	Jolly Old Saint Nicholas
6	Old MacDonald
7	Batter Up!
8	My Clever Pup
9	The Zoo
10	Playing in a New Position
11	Sailing
12	Skating
13	Wishing Well
14	Rain, Rain!
15	A Happy Song
16	Position C
17	A Happy Song
18	See-Saws
19	Just a Second!
20	Balloons
21	Who's on Third?
22	Mexican Hat Dance
23	Rock Song
24	Rockets
25	Sea Divers
26	Play a Fourth
27	July the Fourth!
28	Old Uncle Bill
29	Love Somebody
30	My Fifth
31	The Donkey
32	Position G
33	Jingle Bells!
34	Willie & Tillie
35	A Friend Like You
36	My Robot
37	Rockin' Tune
38	Indian Song
39	Raindrops
40	It's Halloween!
41	Horse Sense

No.	Alfred's Basic Piano Library Lesson Book Level 1B
1	Step Right Up!
2	The Carousel
3	Hail to Thee, America!
4	Brother John
5	Good Sounds
6	The Cuckoo
7	Money Can't Buy Ev'rything!
8	Ping-Pong
9	Grandpa's Clock
10	When the Saints Go Marching In
11	G's in the "BAG"
12	Join the Fun
13	Oom-Pa-pa!
14	The Clown
15	Thumbs on C!
16	Waltz Time
17	Good King Wenceslas
18	The Rainbow
19	Yankee Doodle
20	The Windmill
21	Indians
22	New Position G
23	Pedal Play
24	Harp Song
25	Concert Time
26	Music Box Rock
27	A Cowboy's Song
28	The Magic Man
29	The Greatest Show on Earth!
30	The Whirlwind
31	The Planets
32	C Major Scale Piece
33	G Major Scale Piece
34	Carol in G Major
35	The Same Carol in C Major
36	French Lullaby
37	Sonatina
38	When Our Band Goes Marching By!

No.	Burgmüller 25 (25 Etudes Faciles, Opus 100)
1	La candeur
2	Arabesque
3	Pastorale
4	Petite réunion
5	Innocence
6	Progrès
7	Courant Limpide
8	La gracieuse
9	La chasse
10	Tendre fleur
11	La bergeronnette
12	Adieu
13	Consolation
14	La styrienne
15	Ballade
16	Douce plainte
17	Babillarde
18	Inquiétude
19	Ave Maria
20	Tarentelle
21	Harmonie des anges
22	Barcarolle
23	Retour
24	L'hirondelle
25	La chevaleresque

Czerny 30 (Etudes de Mécanisme, Opus 849)
No. 1 to No. 30

Beyer 106
No. 1 (1-1 to 1-12)
No. 2 (2-1 to 2-8)
No. 3 to No. 106

## ■ Lesson Function song book availability

Alfred's Basic Piano Library, Burgmüller: *Etudes Faciles*, Czerny: *Etudes de Mécanisme*, and Beyer lesson song books are sold separately. Please check your local dealer for more information. Alfred's international offices may also be contacted directly:

**USA / Canada**  
 Alfred Music Publishing  
 PO Box 10003  
 Van Nuys, CA 91410  
 Tel: +1 (800) 292-6122  
 Email: sales@alfred.com  
 Website: <http://www.alfred.com>

**Australia**  
 Alfred Publishing Australia  
 PO Box 2355  
 Taren Point NSW 2229  
 Tel: +61 (02) 9524 0033  
 Email: sales@alfredpub.com.au

# Specifications

## ■ Kawai CN27 digital piano

<b>Keyboard</b>	88 weighted keys with Ivory Touch key surfaces Responsive Hammer III (RHIII) action with Let-Off, Triple Sensor, and Counterweights	
<b>Sound Source</b>	Progressive Harmonic Imaging™ (PHI), 88-key piano sampling	
<b>Internal Sounds</b>	SK Concert Grand, EX Concert Grand, Upright Piano, Studio Grand, Studio Grand 2, Mellow Grand, Mellow Grand 2, Modern Piano, Classic E.Piano, Modern E.Piano, Jazz Organ, Church Organ, Harpsichord, Vibraphone, String Ensemble, Slow Strings, Choir, New Age Pad, Atmosphere	
<b>Polyphony</b>	max. 192 notes	
<b>Reverb</b>	Room, Lounge, Small Hall, Concert Hall, Live Hall, Cathedral	
<b>Internal Recorder</b>	3 song recorder – approximately 10,000 note memory capacity	
<b>Lesson Function</b>	Alfred, Burgmüller, Czerny and Beyer lesson songs	
<b>Metronome</b>	Beat: 1/4, 2/4, 3/4, 4/4, 5/4, 3/8, 6/8 Tempo: 10~300 bpm	
<b>Demo Songs</b>	19 songs	
<b>Keyboard Modes</b>	Dual Mode (with adjustable volume balance) Four Hands Mode	
<b>Virtual Technician</b>	Smart Mode:	10 presets
	Advanced Mode: (adjustable via iPad app)	Touch Curve, Voicing, Damper Resonance, Damper Noise, String Resonance, Key-off Effect, Fall-back Noise, Hammer Delay, Topboard Simulation, Decay Time, Minimum Touch, Stretch Tuning, Temperament, Temperament Key, User Key Volume, Half-Pedal Adjust, Soft Pedal Depth
<b>Other Functions</b>	Sound Preview, Vocal Assist, Brilliance, Tuning, Transpose, Touch, Transmit Program Change Number, MIDI Channel, Local Control, Multi-timbral mode, Spatial Headphone Sound, Phones Type, Startup Settings, Auto Power Off, Bluetooth MIDI	
<b>Bluetooth *</b>	Bluetooth (Ver. 4.0; GATT compatible) Bluetooth Low Energy MIDI Specification compliant	
<b>Pedals</b>	Sustain (with half-pedal support), Soft, Sostenuto	
<b>Jacks</b>	MIDI (IN/OUT), Headphones x 2, USB to HOST	
<b>Speakers</b>	12 cm x 2	
<b>Output Power</b>	20 W x 2	
<b>Power Consumption</b>	11 W (PS-154 AC adaptor)	
<b>Key Cover</b>	Sliding type	
<b>Dimensions</b>	1350 (W) x 405 (D) x 860 (H) (Folding music rest)	
<b>Weight</b>	43.0 kg	

Specifications are subject to change without notice.

\* Availability of Bluetooth function dependent on market location.



# **KAWAI**

---

THE FUTURE OF THE PIANO

